



Surge protection

Protection for superior system availability

Protection for superior system availability

Powerful and reliable

Our products for the operational safety of electrical systems, installations, and devices enable you to effortlessly create an uninterruptable and clean power supply, as well as a stable data connection. With our coordinated product portfolio for surge protection, a protection concept can be created for practically any application.



1

Surge protection for power supplies

From feed-in through to the end device: Increase the availability of your system with our surge protection.

More information starting on page 6



2

Surge protection for MCR technology

Powerful protective devices with low voltage protection levels provide optimum protection for your MCR applications.

More information starting on page 40

5

Test and monitoring devices

Would you like to keep the availability of your system at a constantly high level? Then use our products for preventive monitoring before failures arise.

More information starting on page 82



3

Surge protection for information technology

Safeguard your data cables. Fast signals require one thing above all else – protection that responds very quickly.

More information starting on page 68

4

Surge protection for transmitter and receiver systems

Antennas are often in exposed locations. Therefore, use high-performance surge protection with low attenuation for your system.

More information starting on page 78

Contents

Interference-free power supply and signal transmission	4
Surge protection for power supplies	6
Universal protection for power supply systems	8
Application-related protection	20
Protection directly at the end device	32
Surge protection for measurement and control technology	40
Compact for every application	44
Intelligent and predictive	54
Space-saving for high signal voltages	60
Robust for application in the field	64
Surge protection for information technology	68
Universal protection	70
Compact protection	73
Intelligent protection	76
Surge protection for transmitter and receiver systems	78
Antenna inputs satellite receiver technology	80
Antennas with N, BNC and SMA connection	81
Test and monitoring devices	82
Intelligent assistance system	84
Test system for surge protection	86
Lightning monitoring system	88

Interference-free power supply and signal transmission

Surge voltages – the underestimated danger

Several million lightning strikes occur throughout the world every single day. Ten percent of these are ground bolts with surge currents up to 200,000 amps. In addition to the discharges caused by thunderstorms, surge voltages also occur within local power grids. These are caused, for example, by switching operations and electrostatic discharges. Whatever their cause, time and again surge voltages lead to device defects and system failures.



Fundamental protective measures and devices

Several coordinated protective measures and protective devices are necessary to ensure comprehensive protection of buildings and systems against the impact of lightning strikes and surge voltages. These can be split roughly into the following categories:

External lightning protection:

External lightning protection systems are designed to give the lightning bolt a defined path to ground and thus prevent it from striking the object.

Internal lightning protection:

Internal lightning protection systems are designed to prevent dangerous sparking within the system.

Grounding and equipotential bonding:

Grounding systems are designed to distribute the dissipated lightning current into the ground.

Coordinated SPD system

A coordinated SPD system is a multi-level, coordinated system of surge protective devices.

- Type 1 protection level: Powerful lightning current arrester (type 1+2 combined lightning current and surge arrester or type 1+2 special combined lightning current and surge arrester)
- Type 2 protection level: Protection against surge voltages caused by indirect lightning strikes and switching operations (type 2 surge protective device)
- Type 3 protection level: Surge protection for sensitive end devices (type 3 device protection)

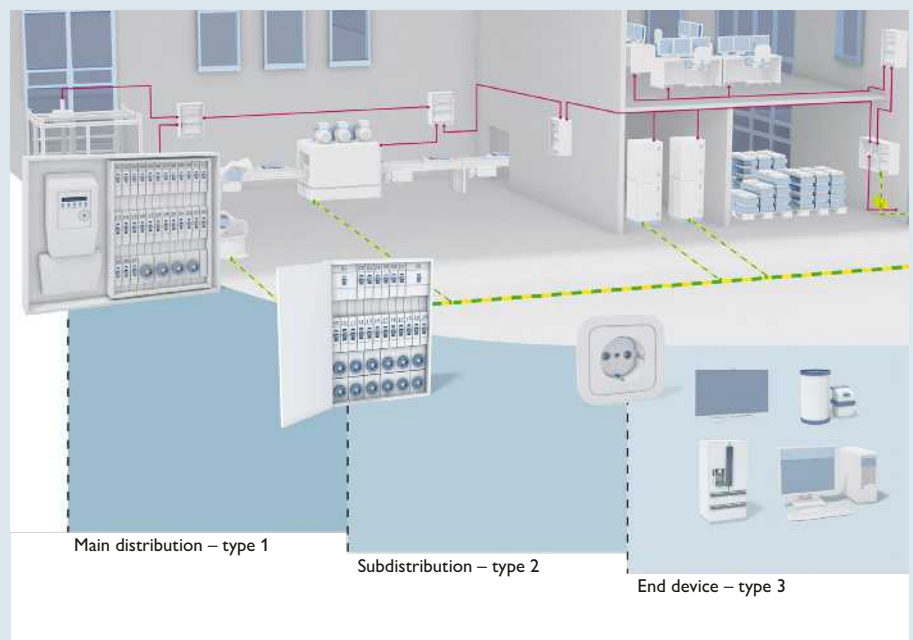

Three-level protection concept in a building

Interference-free power supply and signal transmission

All-round safety with the protective circuit

The protective circuit principle defines complete protection against surge voltages. An imaginary circle is drawn around the devices, plants, or systems to be protected. At all points where cables, conductors, or lines intersect this circle, surge protective

devices that correspond to the rated data of the respective power supply or signal type must be installed. In order to consistently protect objects against conducted surge voltage couplings, the following areas should be considered:

Transmitter and receiver systems

Protective devices for protecting company and cellular communications as well as for satellite and radio systems ensure interference-free reception.

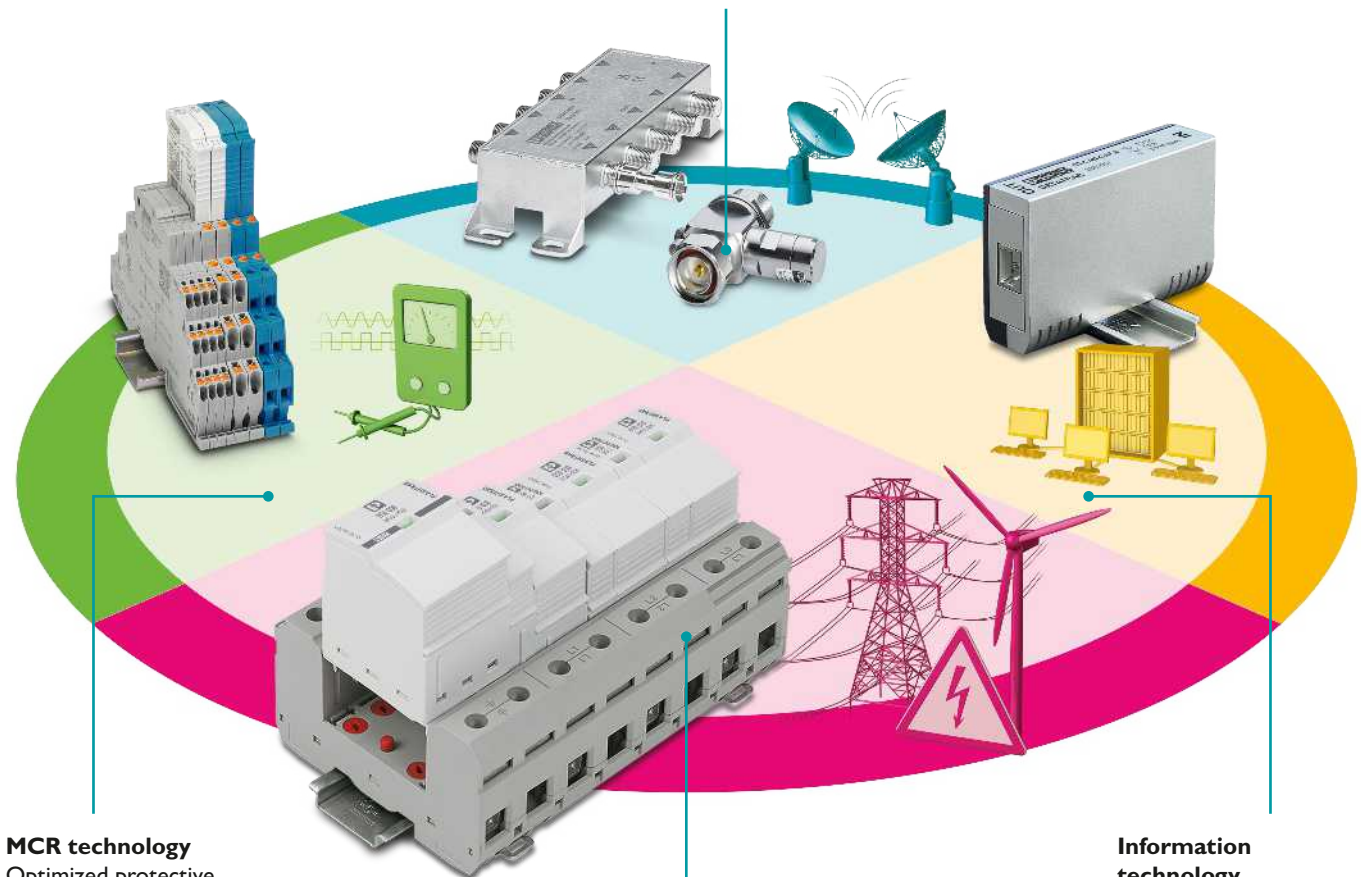

MCR technology

Optimized protective devices are available for the various signal types and measuring principles.

Power supply

Perfectly coordinated protective devices for feed-in points, distributors, and end devices safeguard the power supply.

Information technology

High-speed protection (CAT.6+) for data and communication technology.

Surge protection for power supplies

1

The power supply is the part of a system in which particularly high surge voltages occur. All system parts, from the incoming supply to the load, can be directly affected. A powerful surge protection system ensures an uninterruptible power supply, and thus also a high level of system availability.

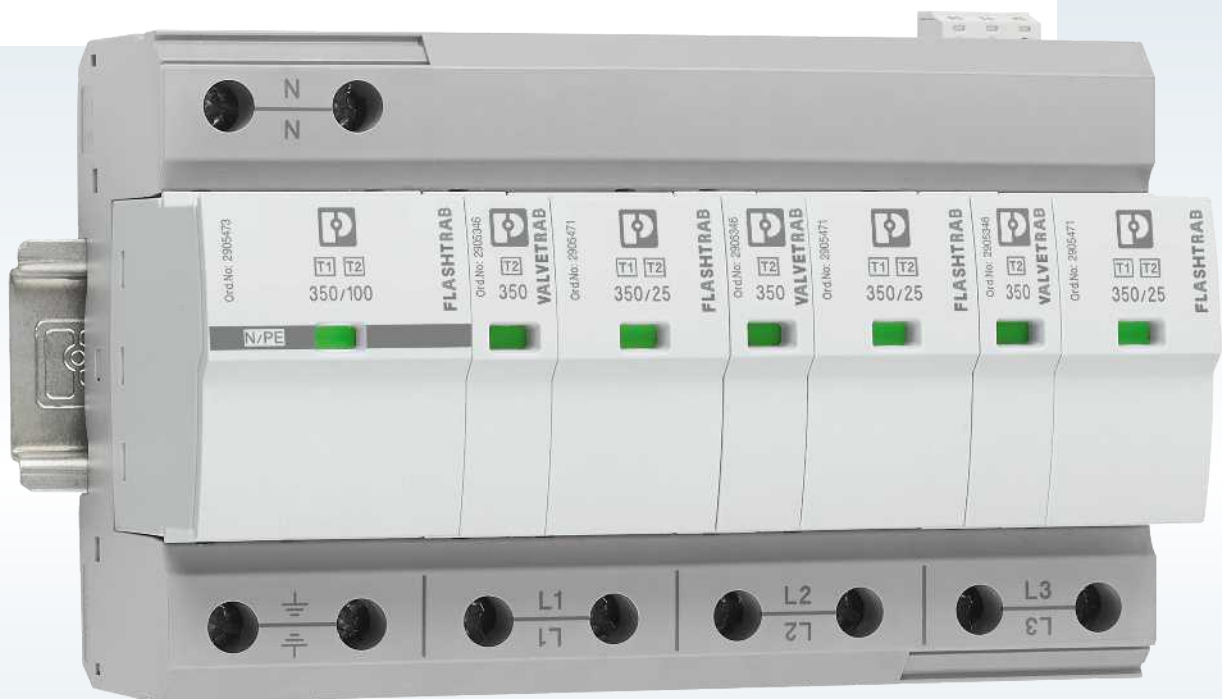

Universal protection

Products of the SEC family are the first choice for integrating surge protection into industrial systems and control cabinets.

More information starting on page 8



Application-related protection

Each application has its own special conditions and requirements. Therefore, the surge protection should be tailored to these as best as possible. The right products for protecting individual requirements.

More information starting on page 20

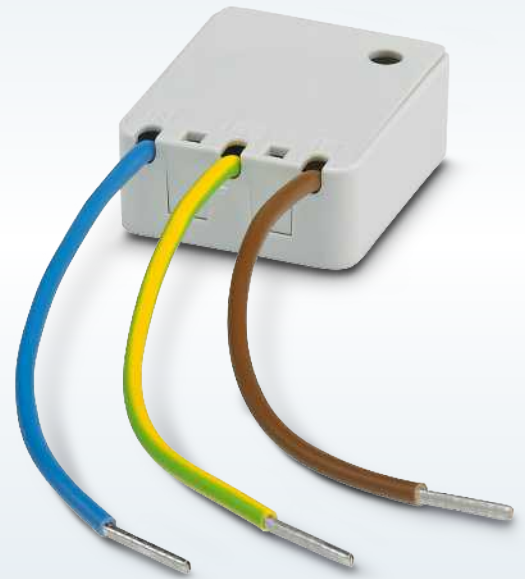

Protection directly at the end device

Sensitive end devices need special protection. Generally, this is installed directly upstream of the end devices to be protected. Various designs enable installation in a wide range of applications.

More information starting on page 32

Surge protection for power supplies

The product family for the protection of power supply systems

The surge protective devices of the Safe Energy Control product family form a comprehensive easy-to-install package which combines maximum performance with high durability. This gives electronic loads reliable protection and reduces maintenance costs. Installing the surge protective devices is easy, cost-effective, and space-saving.



Your advantages

- ✓ Can be used in all conventional power supply systems
- ✓ High system availability with spark gap technology without line follow current
- ✓ Consistent protection across all protection levels
- ✓ Space-saving and cost-effective installation

Type 1+2, type 2, and type 3 surge protective devices



Type 1+2 combined lightning current and surge arrester

Typical installation location: feed-in. Satisfies requirements on test class T1 (lightning current arrester) and T2 (surge protective device).



Type 2 surge protective device

Typical installation location: subdistribution systems, machine control cabinets. Surge protective device in accordance with test class T2.



Type 3 device protection

Typical installation location: Directly at the end device. Surge protective device in accordance with test class T3.

Type 1+2 special combined lightning current and surge arrester

The type 1+2 special combined lightning current and surge arrester differs fundamentally from the type 1+2 version. This is because the type 1+2 special combined lightning current and surge arrester contains two independent protective devices that are connected in parallel in a very small space. A combination of a type 1 spark gap without line follow current and a type 2 varistor arrester in one protective device.

The voltage-switching spark gap (SPD type 1+2) works ideally in combination with a voltage-limiting varistor (SPD type 2). In this combination, two autonomous protective devices in one compact block ensure optimum response behavior, optimal system protection, and a long service life for the components.

The type 1+2 special combined lightning current and surge arrester is perfectly suited for maximum protection of installations and devices.



Type 1+2 special combined lightning current and surge arrester – FLT-SEC-T1+T2-3S-350

Type 1+2 combined lightning current and surge arresters with integrated backup fuse

The FLT-SEC-HYBRID is a combination of a spark gap without line follow current and a surge-proof fuse, and can therefore be used without a separate backup fuse. This means that long cable routes from and to the backup fuse are no longer needed. This has further positive effects on the voltage protection level.

With a short-circuit current rating up to 100 kA, use in large power distribution systems is also possible.



Type 1+2 combined lightning current and surge arrester – FLT-SEC-H-T1-1C-264/25

Universal protection for power supply systems

For universal use

With the surge protective devices of the SEC family, you can protect practically any power supply in standard applications against surge voltages.

From system manufacturing and machine building, to building installation, right through to infrastructure applications, the broad portfolio of the SEC family features products for comprehensive protection concepts.

All of the type 1+2, type 2, and type 3 surge protective devices feature extraordinary durability and high performance in the field of lightning current and surge protection.

Installation is cost-effective and space-saving due to the uniform compact design of the surge protective devices and the fact that they do not need a backup fuse.



Tailored to the demand

The FLT-SEC-ZP2 combined lightning current and surge arrester has been designed specially for installation on the 40 mm busbar system. It is very easy to mount and saves space. Naturally, it satisfies all of the necessary technical requirements of the VDE-AR-N 4100 code of practice.

The FLT-SEC-ZP2 fits into every meter cabinet, regardless of the manufacturer. Feed-in can be done flexibly via the SH switch, a feed-in adapter, or busbar terminals.

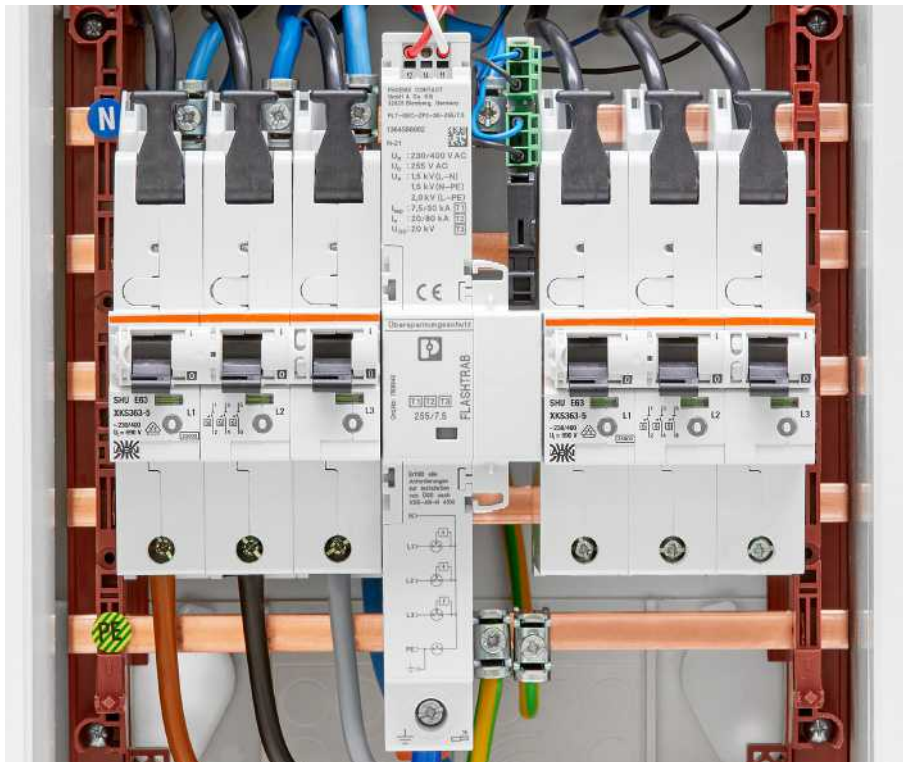

Advantages for your control cabinet manufacturing



Efficient

Plan your control cabinets more efficiently and easily with compact surge protective devices for backup-fuse-free applications. Due to their uniform design and uniform haptics, installing the SEC family products is very easy.



Pluggable

Consistent pluggability ensures a high degree of convenience, for example when taking insulation measurements in the system. Instead of reaching into the system, simply pull the plug. In the unlikely event of a defective protective plug, it is very easy to replace.



Testable

Standard-compliant testing and documentation. Use the CHECKMASTER 2 to test the condition of pluggable surge protection modules. At the same time, you can also document the tests directly in accordance with IEC 62305.



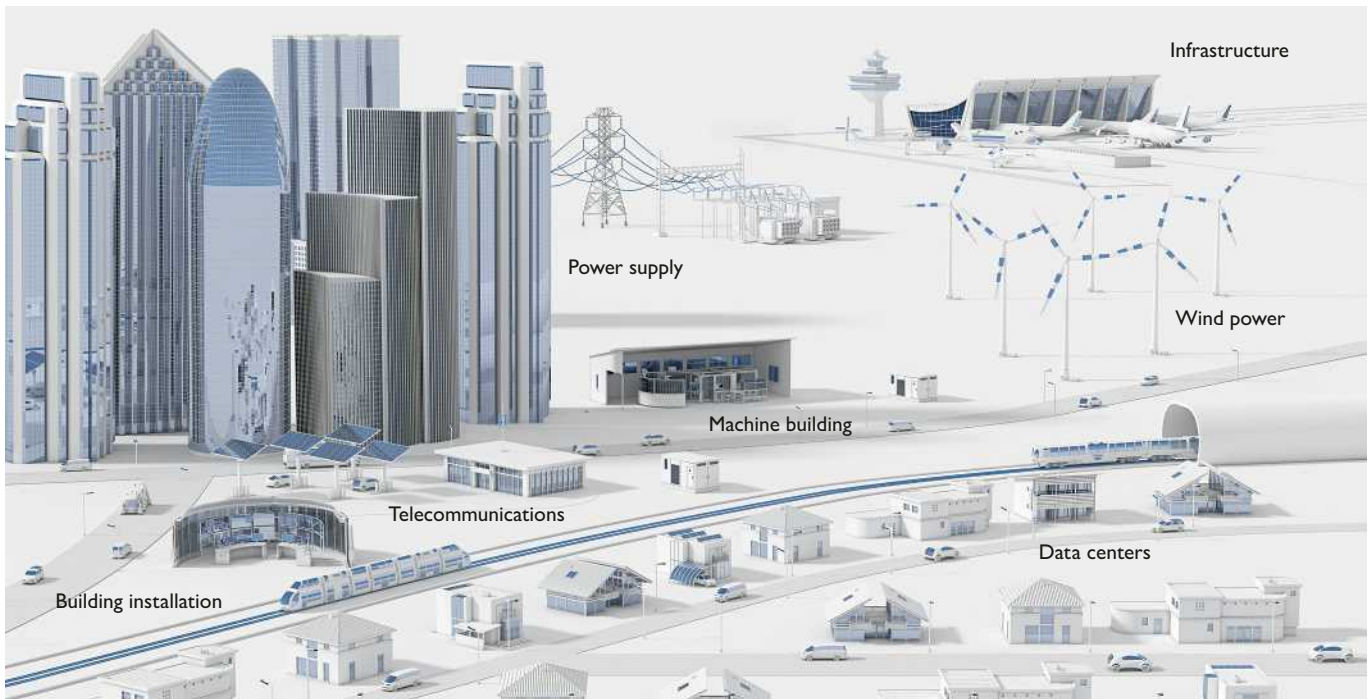







For installation in any control cabinet













With coordinated voltage versions, the surge protective devices of the SEC family can be used in all conventional power supply systems for standard installation applications.

Universal protection for power supply systems

Type 1+2 combined lightning current and surge arresters with integrated backup fuse









 					
Number of positions		1-pos.	3-pos.	1-pos.	3-pos.
Nominal voltage		240 V AC (TN-C)	240/415 V AC (TN-C)	400 V AC (TN) 400 V AC (IT)	400/690 V AC (TN-C) 400 V AC (IT)
Type in accordance with IEC		T1 / T2	T1 / T2, T1	T1 / T2	T1 / T2
Maximum continuous operating voltage U_c		264 V AC	264 V AC	440 V AC	440 V AC
Voltage protection level		≤ 1.5 kV	≤ 1.5 kV	≤ 2.5 kV	≤ 2.5 kV
Approvals		ERC  CB	ERC  CB	ERC  CB	ERC  CB
Nominal discharge current		25 kA	25 kA	25 kA	25 kA
Lightning impulse current		25 kA	25 kA	25 kA	25 kA
Type		FLT-SEC-H-T1-1C-264/25-FM	FLT-SEC-H-T1-3C-264/25-FM	FLT-SEC-H-T1-1C-440/25-FM	FLT-SEC-H-T1-3C-440/25-FM
Item number		2801615	2905871	2907259	2907260

Type 1+2 combined lightning current and surge arresters with high short-circuit current rating, also for unstable grids

 				
Number of positions		2-pos.	3-pos.	4-pos.
Nominal voltage		240 V AC (TN-S) 240 V AC (TT)	240/415 V AC (TN-C)	240/415 V AC (TN-S) 240/415 V AC (TT)
Type in accordance with IEC		T1 / T2	T1 / T2	T1 / T2
Maximum continuous operating voltage U_c		350 V AC	350 V AC	350 V AC
Voltage protection level		≤ 1.5 kV (L-N) ≤ 1.5 kV (N-PE)	≤ 1.5 kV	≤ 1.5 kV (L-N) ≤ 1.5 kV (N-PE)
Max. backup fuse F2		315 A (gG)	315 A (gG)	315 A (gG)
Approvals		 ERC  CB	 ERC  CB	 ERC  CB
Nominal discharge current		25 kA (L-N) 100 kA (N-PE)	25 kA	25 kA (L-N) 100 kA (N-PE)
Lightning impulse current		25 kA (L-N) 100 kA (N-PE)	25 kA	25 kA (L-N) 100 kA (N-PE)
Type		FLT-SEC-P-T1-1S-350/25-FM	FLT-SEC-P-T1-3C-350/25-FM	FLT-SEC-P-T1-3S-350/25-FM
Item number		2905415	2905419	2905421









Universal protection for power supply systems

Type 1+2 combined lightning current and surge arresters for 400/690 V and 400 V IT and a high short-circuit current rating









 			
Number of positions	1-pos.	3-pos.	4-pos.
Nominal voltage	400 V AC (TN) 400 V AC (IT)	400/690 V AC (TN-C) 400 V AC (IT)	400/690 V AC (TN-S) 400/690 V AC (TT)
Type in accordance with IEC	T1 / T2	T1 / T2	T1 / T2
Maximum continuous operating voltage U_c	440 V AC	440 V AC	440 V AC
Voltage protection level	≤ 2.5 kV	≤ 2.5 kV	≤ 2.5 kV (L-N) ≤ 2.5 kV (N-PE)
Max. backup fuse F2	400 A (gG)	400 A (gG)	400 A (gG)
Approvals			
Nominal discharge current	35 kA	35 kA	35 kA (L-N) 100 kA (N-PE)
Lightning impulse current	35 kA	35 kA	35 kA (L-N) 100 kA (N-PE)
Type	FLT-SEC-P-T1-1C-440/35-FM	FLT-SEC-P-T1-3C-440/35-FM	FLT-SEC-P-T1-3S-440/35-FM
Item number	2905987	2905988	2908264

Universal protection for power supply systems

Type 1+2 combined lightning current and surge arresters for very high lightning currents and a high short-circuit current rating









 				
Number of positions		2-pos.	3-pos.	4-pos.
Nominal voltage		240 V AC (TN-S) 240 V AC (TT)	240/415 V AC (TN-C)	240/415 V AC (TN-S) 240/415 V AC (TT)
Type in accordance with IEC		T1 / T2	T1 / T2	T1 / T2
Maximum continuous operating voltage U_c		264 V AC (L-N) 350 V AC (N-PE)	264 V AC	264 V AC (L-N) 350 V AC (N-PE)
Voltage protection level		≤ 2.5 kV (L-N) ≤ 1.5 kV (N-PE)	≤ 2.5 kV	≤ 2.5 kV (L-N) ≤ 1.5 kV (N-PE)
Max. backup fuse F2		500 A (gG)	500 A (gG)	500 A (gG)
Approvals				
Nominal discharge current		50 kA (L-N) 100 kA (N-PE)	50 kA	50 kA (L-N) 100 kA (N-PE)
Lightning impulse current		50 kA (L-N) 100 kA (N-PE)	50 kA	50 kA (L-N) 100 kA (N-PE)
Type		FLT-SEC-P-T1-1S-264/50-FM	FLT-SEC-P-T1-3C-264/50-FM	FLT-SEC-P-T1-3S-264/50-FM
Item number		2907388	2907390	2909589

Type 1+2 special combined lightning current and surge arresters, lightning current arrester and surge protection



 				
Number of positions		2-pos.	3-pos.	4-pos.
Nominal voltage		240 V AC (TN-S) 240 V AC (TT)	240/415 V AC (TN-C)	240/415 V AC (TN-S) 240/415 V AC (TT)
Type in accordance with IEC		T1 + T2	T1 + T2	T1 + T2
Maximum continuous operating voltage U_c		350 V AC	350 V AC	350 V AC
Voltage protection level		≤ 2.2 kV (L-PE) ≤ 1.5 kV (L-N) ≤ 1.5 kV (N-PE)	≤ 1.5 kV	≤ 2.2 kV (L-PE) ≤ 1.5 kV (L-N) ≤ 1.5 kV (N-PE)
Max. backup fuse F2		315 A (gG)	315 A (gG)	315 A (gG)
Approvals				
Nominal discharge current		25 kA (L-N) 25 kA (L-PE) 100 kA (N-PE)	25 kA	25 kA (L-N) 25 kA (L-PE) 100 kA (N-PE)
Lightning impulse current		25 kA (L-N) 25 kA (L-PE) 100 kA (N-PE)	25 kA	25 kA (L-N) 25 kA (L-PE) 100 kA (N-PE)
Type		FLT-SEC-T1+T2-1S-350/25-FM	FLT-SEC-T1+T2-3C-350/25-FM	FLT-SEC-T1+T2-3S-350/25-FM
Item number		2905466	2905469	2905470

Universal protection for power supply systems

Type 1+2+3 combined lightning current and surge arresters for 40 mm busbar systems

								
	Number of positions	4-pos.	new	3-pos.	new	4-pos.	new	3-pos.
Nominal voltage	230/400 V AC (TN-S) 230/400 V AC (TT)		230/400 V AC (TN-C)		230/400 V AC (TN-S) 230/400 V AC (TT)		230/400 V AC (TN-C)	
Type in accordance with IEC	T1 + T2 + T3		T1 + T2 + T3		T1 + T2 + T3		T1 + T2 + T3	
Maximum continuous operating voltage U_c	255 V AC		255 V AC		255 V AC		255 V AC	
Voltage protection level	≤ 1.5 kV (L-N) ≤ 1.5 kV (N-PE)		≤ 1.5 kV		≤ 1.5 kV (L-N) ≤ 1.5 kV (N-PE)		≤ 1.5 kV	
Max. backup fuse F2	160 A (gG)		160 A (gG)		160 A (gG)		160 A (gG)	
Approvals								
Nominal discharge current	20 kA (L-N) 80 kA (N-PE)		20 kA		20 kA (L-N) 80 kA (N-PE)		20 kA	
Lightning impulse current	7.5 kA (L-N) 30 kA (N-PE)		7.5 kA		12.5 kA (L-N) 50 kA (N-PE)		12.5 kA	
Combined surge	20 kV		20 kV		20 kV		20 kV	
Type	FLT-SEC-ZP2-3S-255/7.5		FLT-SEC-ZP2-3C-255/7.5		FLT-SEC-ZP2-3S-255/12.5		FLT-SEC-ZP2-3C-255/12.5	
Item number	1168940		1168942		1168943		1168946	

Type 2 surge protective devices for 240/415 V systems





 						
	Number of positions	2-pos.		3-pos.		4-pos.
Nominal voltage	240 V AC (TN-S) 240 V AC (TT)		240/415 V AC (TN-C)		240/415 V AC (TN-S) 240/415 V AC (TT)	
Type in accordance with IEC	T2		T2		T2	
Maximum continuous operating voltage U_c	350 V AC (L-N) 264 V AC (N-PE)		350 V AC		350 V AC (L-N) 264 V AC (N-PE)	
Voltage protection level	≤ 1.5 kV (L-N) ≤ 1.5 kV (N-PE)		≤ 1.5 kV		≤ 1.5 kV (L-N) ≤ 1.5 kV (N-PE)	
Max. backup fuse F2	315 A (gG)		315 A (gG)		315 A (gG)	
Approvals						
Nominal discharge current	20 kA		20 kA		20 kA	
Type	VAL-SEC-T2-1S-350-FM		VAL-SEC-T2-3C-350-FM		VAL-SEC-T2-3S-350-FM	
Item number	2905333		2905339		2905340	

Universal protection for power supply systems

Type 2 surge protective devices for 240/415 V systems, free of leakage current, also for unstable grids

			
	2-pos.	3-pos.	4-pos.
Number of positions	2-pos.	3-pos.	4-pos.
Nominal voltage	240 V AC (TN-S) 240 V AC (TT)	240/415 V AC (TN-C)	240/415 V AC (TN-S) 240/415 V AC (TT)
Type in accordance with IEC	T2	T2	T2
Maximum continuous operating voltage U_c	350 V AC (L-N) 264 V AC (N-PE)	350 V AC	350 V AC (L-N) 264 V AC (N-PE)
Voltage protection level	≤ 1.5 kV (L-N) ≤ 1.5 kV (N-PE)	≤ 1.5 kV	≤ 1.5 kV (L-N) ≤ 1.5 kV (N-PE)
Max. backup fuse F2	200 A (gG)	200 A (gG)	200 A (gG)
Approvals	ERC	ERC	ERC
Nominal discharge current	10 kA (L-N) 20 kA (N-PE)	10 kA	10 kA (L-N) 20 kA (N-PE)
Type	VAL-SEC-T2-1S-350VF-FM	VAL-SEC-T2-3C-350VF-FM	VAL-SEC-T2-3S-350VF-FM
Item number	2909592	2909591	2909590

Type 2 surge protective devices for 400/690 V and 400 V IT systems

 		
	3-pos.	3-pos.
Number of positions	3-pos.	3-pos.
Nominal voltage	400/690 V AC (TN-C) 400 V AC (IT)	400/690 V AC (TN-S) 400 V AC (IT)
Type in accordance with IEC	T2	T2
Maximum continuous operating voltage U_c	440 V AC	440 V AC
Voltage protection level	≤ 1.9 kV	≤ 4 kV (L-N) ≤ 1.9 kV (N-PE)
Max. backup fuse F2	315 A (gG)	315 A (gG)
Approvals	ERC	-
Nominal discharge current	20 kA	20 kA
Type	VAL-SEC-T2-3C-440-FM	VAL-SEC-T2-4+0-440-FM
Item number	2909968	1076468

Universal protection for power supply systems

Type 2 surge protective devices for 120/208 V systems





 			
	Number of positions	2-pos.	3-pos.
Nominal voltage	120 V AC (TN-S) 120 V AC (TT)	120/208 V AC (TN-C)	120/208 V AC (TN-S) 120/208 V AC (TT)
Type in accordance with IEC	T2	T2	T2
Maximum continuous operating voltage U_c	175 V AC (L-N) 150 V AC (N-PE)	175 V AC	175 V AC (L-N) 150 V AC (N-PE)
Voltage protection level	≤ 0.85 kV (L-N) ≤ 0.95 kV (N-PE)	≤ 0.85 kV	≤ 0.85 kV (L-N) ≤ 0.95 kV (N-PE)
Max. backup fuse F2	315 A (gG)	315 A (gG)	315 A (gG)
Approvals			
Nominal discharge current	20 kA	20 kA	20 kA
Type	VAL-SEC-T2-1S-175-FM	VAL-SEC-T2-3C-175-FM	VAL-SEC-T2-3S-175-FM
Item number	2905348	2905353	2905354

Type 2 surge protective devices for unipolar DC applications





 				
	Number of positions	2-pos.	2-pos.	2-pos.
Type in accordance with IEC	T2	T2	T2	T2
Maximum continuous operating voltage U_c	75 V DC	150 V DC	250 V DC	450 V DC
Voltage protection level	≤ 0.9 kV (DC-DC) ≤ 0.5 kV (DC-PE)	≤ 1.8 kV (DC-DC) ≤ 0.85 kV (DC-PE)	≤ 3 kV (DC-DC) ≤ 1.5 kV (DC-PE)	≤ 3 kV (DC-DC) ≤ 1.5 kV (DC-PE)
Max. backup fuse F2	20 A DC (gG / B at I_{SCCR} >200 A)	20 A (gG / B at I_{SCCR} >200 A)	20 A (gG / B at I_{SCCR} >200 A)	20 A (gG / B at I_{SCCR} >200 A)
Approvals				
Nominal discharge current	20 kA	20 kA	20 kA	20 kA
Type	VAL-SEC-T2-2+0-48DC-FM	VAL-SEC-T2-2+0-120DC-FM	VAL-SEC-T2-2+0-220DC-FM	VAL-SEC-T2-2+0-380DC-FM
Item number	2907865	2907874	2907875	2907876

Universal protection for power supply systems

Type 2 surge protective devices for unipolar insulated DC applications











				
Number of positions	2-pos.	2-pos.	2-pos.	2-pos.
Type in accordance with IEC	T2	T2	T2	T2
Maximum continuous operating voltage U_c	75 V DC	150 V DC	250 V DC	450 V DC
Voltage protection level	≤ 0.9 kV (DC-DC) ≤ 1 kV (DC-PE)	≤ 1.8 kV (DC-DC) ≤ 1.3 kV (DC-PE)	≤ 3 kV (DC-DC) ≤ 1.9 kV (DC-PE)	≤ 3 kV (DC-DC) ≤ 1.9 kV (DC-PE)
Max. backup fuse F2	20 A DC (gG / B at I_{SCCR} >200 A)	20 A (gG / B at I_{SCCR} >200 A)	20 A (gG / B at I_{SCCR} >200 A)	10 A (gG / B at I_{SCCR} >100 A)
Nominal discharge current	20 kA	20 kA	20 kA	20 kA
Type	VAL-SEC-T2-2+F-48DC-FM	VAL-SEC-T2-2+F-120DC-FM	VAL-SEC-T2-2+F-220DC-FM	VAL-SEC-T2-2+F-380DC-FM
Item number	1033786	1033788	1033789	1033790

Type 3 device protection with Push-in connection

 				
Number of positions	2-pos.	2-pos.	2-pos.	2-pos.
Nominal voltage	24 V AC (TN-S)	60 V AC (TN-S)	120 V AC (TN-S) 120 V AC (TT)	240 V AC (TN-S) 240 V AC (TT)
Type in accordance with IEC	T3	T3	T2 / T3	T2 / T3
Maximum continuous operating voltage U_c	34 V AC	80 V AC	150 V AC	264 V AC
Voltage protection level	≤ 0.2 kV (L-N) ≤ 0.6 kV (N-PE)	≤ 0.48 kV (L-N) ≤ 0.8 kV (N-PE)	≤ 0.75 kV (L-N) ≤ 0.85 kV (N-PE)	≤ 1.25 kV (L-N) ≤ 1.4 kV (N-PE)
Max. backup fuse F2	32 A (gG / B / C)	32 A (gG / B / C)	32 A (gG / B / C)	32 A (gG / B / C)
Approvals				
Nominal discharge current	1 kA	2 kA	5 kA	5 kA
Combined surge	2 kV	4 kV	6 kV	6 kV
Type	PLT-SEC-T3-24-FM-PT	PLT-SEC-T3-60-FM-PT	PLT-SEC-T3-120-FM-PT	PLT-SEC-T3-230-FM-PT
Item number	2907925	2907926	2907927	2907928

Universal protection for power supply systems

Type 3 device protection with screw connection

 				
Number of positions	2-pos.	2-pos.	2-pos.	2-pos.
Nominal voltage	24 V AC (TN-S)	60 V AC (TN-S)	120 V AC (TN-S) 120 V AC (TT)	240 V AC (TN-S) 240 V AC (TT)
Type in accordance with IEC	T3	T3	T2 / T3	T2 / T3
Maximum continuous operating voltage U_c	34 V AC	80 V AC	150 V AC	264 V AC
Voltage protection level	≤ 0.2 kV (L-N) ≤ 0.6 kV (N-PE)	≤ 0.48 kV (L-N) ≤ 0.8 kV (N-PE)	≤ 0.75 kV (L-N) ≤ 0.85 kV (N-PE)	≤ 1.25 kV (L-N) ≤ 1.4 kV (N-PE)
Max. backup fuse F2	32 A (gG / B / C)	32 A (gG / B / C)	32 A (gG / B / C)	32 A (gG / B / C)
Approvals				
Nominal discharge current	1 kA	2 kA	5 kA	5 kA
Combined surge	2 kV	4 kV	6 kV	6 kV
Type	PLT-SEC-T3-24-FM-UT	PLT-SEC-T3-60-FM-UT	PLT-SEC-T3-120-FM-UT	PLT-SEC-T3-230-FM-UT
Item number	2907916	2907917	2907918	2907919

Surge protection for power supplies

The ideal protection for special requirements

Provide ideal protection for your systems and investments with products tailored specifically to various requirements – whether for photovoltaic applications, wind turbine generators, or e-mobility charging stations. You will surely find the right surge protection for your special requirement.



Your advantages

- ✓ Optimally tailored protection thanks to sector-specific products
- ✓ Robust and durable with test methods designed for the installation location
- ✓ Market-specific products for compliance with regional standards and stipulations

Application-related protection for different applications

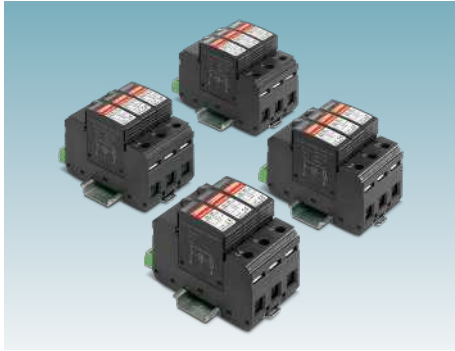

The specialists

From renewable energies through to machine building. VALVETRAB, the variable specialists for different applications.

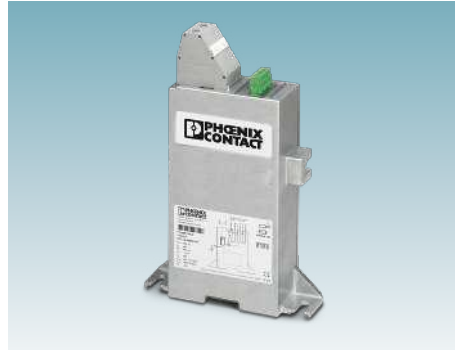

The robust ones

POWERTRAB products are extremely robust high-performance lightning arresters for applications in harsh conditions and exposed locations.











The minimalists

BLOCKTRAB T2 products are ideally suited for protecting LED street lighting. Optimum protection in the tightest spaces.

Surge protection for all energy sectors

With the right surge protection, you ensure the availability of your application. Whether for renewable and thus clean energy generation or for the mobility of the future, the right protection against surge voltages is simply essential. Networked buildings, industrial systems, and the associated infrastructure are the basis for automated value creation. These should be equipped with surge protection specially developed for this purpose.



Photovoltaics	Wind power	E-mobility	Building installation	Machine building	Infrastructure
					
Page 29	Page 31	Page 30	Page 28	Page 27	Page 30
					

The right surge protection for your application

Machine building and systems manufacturing

Control cabinets are the control centers of electrotechnical systems and production facilities. They therefore have to be protected accordingly with care. The sensitive electronic components in the control cabinet have to be protected reliably against surge voltages. They are particularly susceptible to damage caused by lightning currents and surge voltage coupling across the power grid.

In order to avoid costly failures and downtimes, surge protection should be taken into consideration as early as when planning the system components and their supply.

In our broad portfolio of surge protective devices for various applications in machine building and systems manufacturing, you will find the right protection for your application.

Protective devices with specially tailored voltage ranges, integrated, coordinated backup fuses, or, upon request, even versions designed to meet the requirements of global markets increase the availability of your systems and thus protect against costly production downtimes.



Increased system availability

Photovoltaic systems

Solar power is an essential source of renewable energy. Decreasing system costs mean that photovoltaic power generation systems are attractive not only from an ecological perspective. They are also extremely competitive from an economic point of view when compared with conventional power generation. In order to provide optimum protection against surge voltages for the various system parts such as PV panels, inverters, and battery storage systems, surge protection must be used.

The parameters on the DC side of photovoltaic systems differ substantially from those on the AC side. High system DC voltages are generated and a photovoltaic generator is operated close to its short-circuit current. Fuse mechanisms that are typically used for AC applications, such as backup fuses, are not used here. Due to these special features of the DC side, surge protective devices that have been specifically developed for photovoltaic systems must be used.

Phoenix Contact provides a broad product range of surge protective devices specially designed for the DC side of photovoltaic systems.

Type 1+2 combined lightning current and surge arresters as well as type 2 for generator voltages of up to 1,500 V DC are included in this portfolio. Here, you can choose between plug-in and non-plug-in versions.

Naturally, our portfolio does not just include suitable DC and AC surge protection for your photovoltaics application, but also string combiner boxes (SCBs) for rooftop systems and ground-mounted systems.

More information on this topic at: phoe.co/pv-surge



Uninterruptible energy generation

Wind power

Whether on rough seas, flat coastal landscapes, high plateaus, or wide plains, wind turbine generators (WTGs) are exposed to extreme weather conditions wherever installed. These systems, which are up to 200 m high, are particularly at risk during thunderstorms. It is therefore very important to protect the electrical and electronic system parts and components against lightning currents and surge voltages. If a WTG fails, this results in both high yield losses and costly maintenance work.

With its robust housing, the POWERTRAB type 1+2 combined lightning current and surge arrester is specially

designed for harsh conditions. Featuring a rated voltage of 800 V AC and a discharge capacity of 35 kA per channel, it is ideal for use in 690 V IT grids in wind turbine generators.

In addition, the VAL-MS 750 and 800 versions provide specially designed protection for the rotor and stator in wind turbine generators.



Safe system operation in exposed locations

E-mobility

Charging stations and home chargers must be available at all times – day and night, and in any weather. In order to protect the charging infrastructure of your connected e-vehicle against surge voltages caused by lightning strikes or switching operations, it is included in a comprehensive overvoltage protection concept.

This allows you to ensure that the charging process continues uninterrupted and unaffected by surge voltages, and that your electric car is ready for use at any time.

With VAL-EV surge protection, specially developed for charging stations, you can

safely and reliably protect the sensitive electronic components installed in them. The type 1+2 and type 2 protective devices are the ideal protection for the charging infrastructure, and thus also increase the availability of your electric vehicle.



Protection for the charging infrastructure

Infrastructure

LED technology provides durable solutions for road and building lighting. Premature blackouts caused by surge voltages significantly reduce the savings potential of energy-saving LED lights. This is often caused by ballasts which are sensitive to transient voltages. The dimensions of the BLOCKTAB type surge protective devices allow them to be installed directly in the light. Due to the increased insulation, they can be used in LED applications in protection class II equipment without any further measures.





Depending on requirements, the devices can be installed in through-wiring or branch wiring and are designed either as versions for lights with a grounded connection (L, L', N, PE) or for lights with an insulated connection (L, L', N).











Consistent availability

Application-related protection

Type 1+2 combined lightning current and surge arresters for lightning protection level III and IV





		
Number of positions	4-pos.	2-pos.
Nominal voltage	240/415 V AC (TN-S) 240/415 V AC (TT)	240 V AC (TN-S) 240 V AC (TT)
Type in accordance with IEC	T1 / T2	T1 / T2
Maximum continuous operating voltage U_c	335 V AC (L-N) 335 V AC (L-PE) 264 V AC (N-PE)	335 V AC (L-N) 335 V AC (L-PE) 264 V AC (N-PE)
Voltage protection level	≤ 2 kV (L-PE) ≤ 1.2 kV (L-N) ≤ 1.7 kV (N-PE)	≤ 2 kV (L-PE) ≤ 1.2 kV (L-N) ≤ 1.7 kV (N-PE)
Max. backup fuse F2	160 A (gG)	160 A (gG)
Approvals		
Nominal discharge current	12,5 kA (L-N) 12,5 kA (L-PE) 50 kA (N-PE)	12,5 kA (L-N) 12,5 kA (L-PE) 50 kA (N-PE)
Lightning impulse current	12,5 kA (L-N) 12,5 kA (L-PE) 50 kA (N-PE)	12,5 kA (L-N) 12,5 kA (L-PE) 50 kA (N-PE)
Type	VAL-MS-T1/T2 335/12.5/3+1-FM	VAL-MS-T1/T2 335/12.5/1+1-FM
Item number	2800183	2800186

Type 2 surge protection for stable 240/415 V systems

				
Number of positions	1-pos.	2-pos.	4-pos.	4-pos. new
Nominal voltage	240/415 V AC (TN) 240/415 V AC (TT)	240/415 V AC (TN-S) 240/415 V AC (TT)	240/415 V AC (TN-S) 240/415 V AC (TT)	240/415 V AC (TN-S) 240/415 V AC (TT)
Type in accordance with IEC	T2	T2	T2	T2
Maximum continuous operating voltage U_c	275 V AC	275 V AC (L-N) 260 V AC (N-PE)	275 V AC (L-N) 260 V AC (N-PE)	275 V AC (L-N) 260 V AC (N-PE)
Voltage protection level	≤ 1.35 kV	≤ 1.35 kV (L-N) ≤ 1.5 kV (N-PE)	≤ 1.35 kV (L-N) ≤ 1.5 kV (N-PE)	≤ 1.35 kV (L-N) ≤ 1.5 kV (N-PE)
Max. backup fuse F2	125 A (gG)	125 A (gG)	125 A (gG)	125 A (gG)
Approvals				
Nominal discharge current	20 kA	20 kA	20 kA	20 kA
Type	VAL-MS 230	VAL-MS 230/1+1-FM	VAL-MS 230/3+1 FM	VAL-MS 230/3+1 FM-PT
Item number	2839127	2804432	2838199	1248960

Application-related protection

Type 2 surge protection for unstable 240/415 V systems

		
Number of positions	4-pos.	2-pos.
Nominal voltage	240/415 V AC (TN-S) 240/415 V AC (TT)	240/415 V AC (TN-S) 240/415 V AC (TT)
Type in accordance with IEC	T2	T2
Maximum continuous operating voltage U_c	335 V AC (L-N) 260 V AC (N-PE)	335 V AC (L-N) 260 V AC (N-PE)
Voltage protection level	≤ 1.5 kV (L-N) ≤ 1.5 kV (N-PE)	≤ 1.5 kV (L-N) ≤ 1.5 kV (N-PE)
Max. backup fuse F2	125 A (gG)	125 A (gG)
Approvals		
Nominal discharge current	20 kA	20 kA
Type	VAL-MS 320/3+1-FM	VAL-MS 320/1+1-FM
Item number	2859181	2804393

Surge protection for 24 V DC and 48 V DC applications

		
Number of positions	2-pos.	1-pos.
Nominal voltage	60 V AC (TN-S)	60 V AC (TN)
Type in accordance with IEC	T1 / T2	T2
Maximum continuous operating voltage U_c	75 V AC	75 V AC
Voltage protection level	≤ 0.8 kV (L-PE) ≤ 0.4 kV (L-N) ≤ 0.4 kV (N-PE)	≤ 0.55 kV
Max. backup fuse F2	160 A (gG)	125 A AC (gG)
Approvals		
Nominal discharge current	12.5 kA	15 kA
Lightning impulse current	12.5 kA	-
Type	VAL-MS-T1/T2 48/12.5/1+1V-FM	VAL-MS 60/FM
Item number	2801533	2868033

Application-related protection

Type 2 surge protection with high electric strength



Number of positions	1-pos.
Nominal voltage	240/415 V AC (TN) 240/415 V AC (TT) 230 V AC (IT)
Type in accordance with IEC	T2
Maximum continuous operating voltage U_c	350 V AC
Voltage protection level	≤ 1.5 kV
Max. backup fuse F2	125 A (gG)
Approvals	
Nominal discharge current	10 kA
Type	VAL-MS 350 VF/FM
Item number	2856579

Type 2 surge protection for 400/690 V and 400 V IT systems











Number of positions	3-pos.
Nominal voltage	400/690 V AC (TN-C) 500 V AC (IT)
Type in accordance with IEC	T2
Maximum continuous operating voltage U_c	580 V AC
Voltage protection level	≤ 2.5 kV
Max. backup fuse F2	125 A (gG)
Approvals	
Nominal discharge current	15 kA
Type	VAL-MS 580/3+0-FM
Item number	2920447

Application-related protection

UL Listed type 1 surge protection







			
Number of positions	3-pos.	4-pos.	4-pos.
Nominal voltage	120/240 V AC (split phase)	277/480 V AC (Wye)	347/600 V AC (Wye) 400/690 V AC (Wye)
Type in accordance with UL	Type 1	Type 1	Type 1
Maximum continuous operating voltage U_c	350 V AC (L-L) 175 V AC (L-N) 175 V AC (L-G) 305 V AC (N-G)	750 V AC (L-L) 385 V AC (L-N) 385 V AC (L-G) 305 V AC (N-G)	750 V AC (L-L) 580 V AC (L-N) 750 V AC (L-G) 580 V AC (N-G)
Voltage protection level in accordance with UL	1200 V (L-L) 700 V (L-N) 1800 V (L-G) 1200 V (N-G)	2500 V (L-L) 1500 V (L-N) 2000 V (L-G) 1200 V (N-G)	4000 V (L-L) 2000 V (L-N) 4000 V (L-G) 2000 V (N-G)
Approvals			
Nominal discharge current	20 kA	20 kA	20 kA
Type	VAL-US-120/40/2+1-FM	VAL-US-277/40/3+1-FM	VAL-US-347/30/3+1V-FM
Item number	2910352	2910374	1079099

UL Listed type 1 surge protection

				
Number of positions	3-pos.	3-pos.	3-pos.	3-pos.
Nominal voltage	277/480 V AC (3-phase Wye)	347/600 V AC (3-phase Wye) 400/690 V AC (3-phase Wye)	480 V AC (3-phase Delta)	600 V AC (3-phase Delta)
Type in accordance with UL	Type 1	Type 1	Type 1	Type 1
Maximum continuous operating voltage U_c	750 V AC (L-L) 385 V AC (L-G)	750 V AC (L-L) 580 V AC (L-G)	750 V AC (L-L) 580 V AC (L-G)	750 V AC (L-L) 750 V AC (L-G)
Voltage protection level in accordance with UL	2500 V (L-L) 1500 V (L-G)	4000 V (L-L) 2000 V (L-G)	4000 V (L-L) 2000 V (L-G)	4000 V (L-L) 2500 V (L-G)
Approvals				
Nominal discharge current	20 kA	20 kA	20 kA	20 kA
Type	VAL-US-277/80/3+0-FM	VAL-US-347/30/3+0-FM	VAL-US-480D/30/3+0-FM	VAL-US-600D/30/3+0-FM
Item number	1075896	2910383	2910386	2910391







Application-related protection

Type 2 surge protective devices with coordinated backup fuse







				
Number of positions		2-pos.	3-pos.	4-pos.
Nominal voltage		240 V AC (TN-S) 240 V AC (TT)	240/415 V AC (TN-C)	240/415 V AC (TN-S) 240/415 V AC (TT)
Type in accordance with IEC		T2	T2	T2
Maximum continuous operating voltage U_c		350 V AC (L-N) 264 V AC (N-PE)	350 V AC	350 V AC (L-N) 264 V AC (N-PE)
Voltage protection level		≤ 2.5 kV (L-N) ≤ 1.7 kV (N-PE)	≤ 2.5 kV	≤ 2.5 kV (L-N) ≤ 1.7 kV (N-PE)
Approvals				
Nominal discharge current		15 kA (L-N) 20 kA (N-PE)	15 kA	15 kA (L-N) 20 kA (N-PE)
Type		VAL-CP-MCB-1S-350/40/FM	VAL-CP-MCB-3C-350/40/FM	VAL-CP-MCB-3S-350/40/FM
Item number		2882763	2882776	2882750

Application-related protection





Type 1+2 combined lightning current and surge arresters for photovoltaics





			
Number of positions			
Type in accordance with IEC	T1 / T2	T1 / T2	T1 / T2
Maximum continuous operating voltage U_c	720 V DC	1050 V DC	1500 V DC
Voltage protection level	≤ 2.6 kV	≤ 3.5 kV	≤ 4.5 kV
Approvals			
Nominal discharge current	15 kA	15 kA	20 kA
Lightning impulse current	5 kA	5 kA	6.25 kA
Type	VAL-MS-T1/T2 600DC-PV/2+V-FM	VAL-MS-T1/T2 1000DC-PV/2+V-FM	VAL-MB-T1/T2 1500DC-PV/2+V-FM
Item number	2801164	2801161	2905640

Type 2 surge protective devices for photovoltaics

			
Number of positions			
Type in accordance with IEC	T2	T2	T2
Maximum continuous operating voltage U_c	800 V DC	1170 V DC	1500 V DC
Voltage protection level	≤ 2.7 kV	≤ 3.7 kV	≤ 5 kV
Approvals			
Nominal discharge current	15 kA	15 kA	15 kA
Type	VAL-MS 600DC-PV/2+V-FM	VAL-MS 1000DC-PV/2+V-FM	VAL-MS 1500DC-PV/2+V-FM
Item number	2800641	2800627	1033725





Application-related protection

Surge protection for e-mobility			
			
Number of positions	4-pos.	new	4-pos. new
Nominal voltage	240/415 V AC (TN-S) 240/415 V AC (TT)		240/415 V AC (TN-S) 240/415 V AC (TT)
Type in accordance with IEC	T1 / T2		T2
Maximum continuous operating voltage U_c	264 V AC		280 V AC (L-N) 280 V AC (L-PE) 260 V AC (N-PE)
Voltage protection level	≤ 2 kV (L-PE) ≤ 1.2 kV (L-N) ≤ 1.7 kV (N-PE)		≤ 1.9 kV (L-PE) ≤ 1.5 kV (L-N) ≤ 1.5 kV (N-PE)
Max. backup fuse F2	160 A (gG)		125 A (gG)
Approvals			
Nominal discharge current	12,5 kA (L-N) 12,5 kA (L-PE) 50 kA (N-PE)		20 kA
Lightning impulse current	12,5 kA (L-N) 12,5 kA (L-PE) 50 kA (N-PE)		-
Type	VAL-EV-T1/T2 264/12.5/3+1-R		VAL-EV-T2 280/3+1-R
Item number	1180150		1180145





Type 2 surge protective devices for LED applications			
			
Number of positions			
Type in accordance with IEC	T2 / T3		T2 / T3
Maximum continuous operating voltage U_c	320 V AC		320 V AC (L-N) 305 V AC (N-PE)
Voltage protection level	≤ 1.3 kV		≤ 1.3 kV (L-N) ≤ 1.4 kV (N-PE)
Max. backup fuse F2	16 A (MCB B/C)		16 A (MCB B/C)
Approvals			
Nominal discharge current	5 kA		5 kA (L-N) 10 kA (N-PE)
Type	BLT-T2-320-UT		BLT-T2-1S-320-UT
Item number	2906100		2906101

Application-related protection

Type 1+2 combined lightning current and surge arresters for high nominal voltages

		
Number of positions	1-pos.	3-pos.
Nominal voltage	690 V AC 554/960 V AC (TN-C) 690 V AC (IT)	690 V AC 554/960 V AC (TN-C) 690 V AC (IT)
Type in accordance with IEC	T1 / T2	T1 / T2
Maximum continuous operating voltage U_c	800 V AC (L-PE)	800 V AC (L-PE)
Voltage protection level	≤ 4.5 kV	≤ 4.5 kV
Max. backup fuse F2	400 A (gG at 2 x 50 mm ²)	400 A (gG at 2 x 50 mm ²)
Approvals		
Nominal discharge current	35 kA (L-PE)	35 kA (L-PE)
Lightning impulse current	35 kA	35 kA
Type	PWT 35-800AC-FM	PWT 100-800AC-FM
Item number	2800419	2800531

Generator protection for stator and rotor

		
Number of positions	3-pos.	2-pos.
Nominal voltage	554/960 V AC (TN-C) 690 V AC (IT)	400/690 V AC (TN-C) 690 V AC (IT)
Type in accordance with IEC	T2	T2
Maximum continuous operating voltage U_c	760 V AC	800 V AC
Voltage protection level	≤ 2.9 kV	≤ 5 kV
Max. backup fuse F2	100 A (gG)	100 A (gG)
Approvals		
Nominal discharge current	15 kA	15 kA
Type	VAL-MS 750/30/3+0-FM	VAL-MS 800/30 VF/FM
Item number	2920272	2805402

Surge protection for power supplies

The extra protection for sensitive end devices

Modern residential and commercial buildings are increasingly becoming more intelligent. There is no longer any family home or commercial building without the sensitive technology that belongs to everyday life. To protect these sensitive end devices, you need type 3 device protection as the third and last protection level. The important requirement is that type 2 surge protection must already be installed in the subdistribution.



Your advantages

- ✓ Variable in installation with different designs
- ✓ Powerful protection for AC and DC applications enables use in a variety of applications
- ✓ Disconnect device provides increased safety in the event of electrical and thermal overload

Device protection for different applications



Intermediate plugs

The adapters for mains sockets are ideal for retrofitting surge protection upstream of electronic end devices.

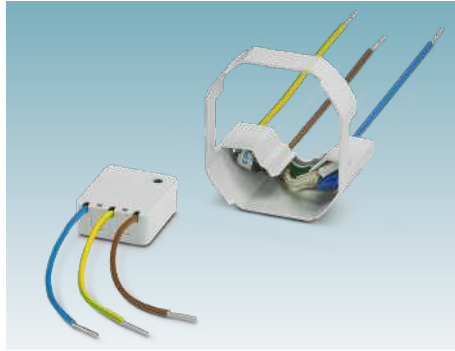

Installation boxes and ducts

The hidden device protection system for installation boxes, cable ducts, and underfloor systems.



PCB mounting

Surge protection directly on the printed circuit board. Powerful for single-phase applications in particularly small devices.

Surge protection for I/Os and controllers

Based on the 6 mm wide TERMITRAB complete range, the TTC type 3 protects the 24 V power supplies of end devices such as I/Os and controllers against surge voltages from the field.

Moreover, the TTC type 3 can be used to protect a potential distribution system from the CLIPLINE complete terminal block program and PTCB device circuit breakers directly against surge voltages. Of the same contour as the TTC type 3, the PTCB electronic circuit breakers are the ideal overcurrent protection for your end devices.

More information on electronic circuit breakers at:
phoe.co/electronic-circuit-breakers

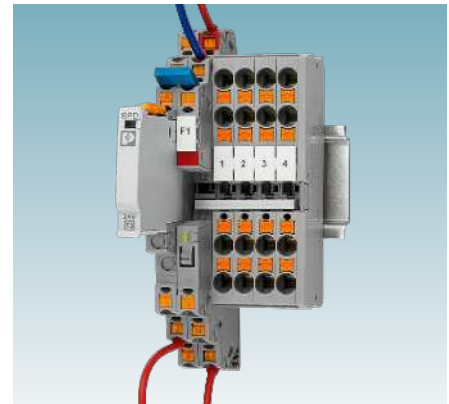

Protect potential distribution systems directly against surge voltages.

Protection directly at the end device

Surge protection and power supply for high system availability

For extreme operating conditions, use the ideally matched combination of the PLUGTRAB SEC surge protective device and the powerful 4th generation QUINT POWER power supply.

Higher current carrying capacity

Using harmonized surge protective components enables symmetrical current distribution when overvoltage occurs.

Up to ten times higher protection

By using the type 3 PLT-SEC surge protective device, the QUINT POWER 4th generation power supply is ten times better able to withstand surge currents than it would be without the protection.

Double the life expectancy

A comparison to uncoordinated products shows that our combination of PLT-SEC surge protection and QUINT POWER 4th generation power supply doubles the power supply's life expectancy.

5-year warranty

If your 4th generation QUINT POWER becomes damaged in the first five years following purchase despite the using this combination, you will receive a free replacement.

For further information and conditions, see our website at:
phoe.co/perfectteam

For an overview of the PLT-SEC type 3 product, see page 36.



A strong team combining surge protection and a power supply.

Surge protection for printed-circuit boards

The PRINTRAB series enables powerful type 2 surge protection in a confined space. Installed directly on the PCB, it provides protection for single-phase applications in very small devices. There are numerous fields of application, such as the future 5G communication system and integration into inverters.

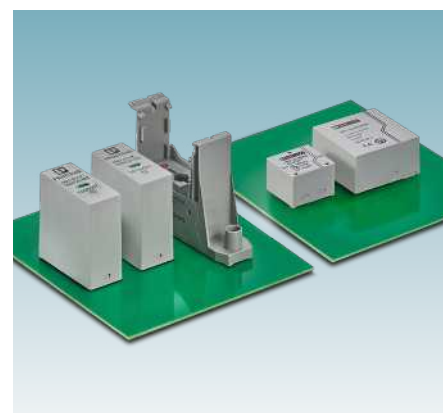

High-level protection in the tightest spaces

Protection directly at the end device

Building installation

Modern residential buildings feature comprehensive technical equipment that makes life easier. Devices failing due to a surge voltage do not just cause an inconvenience. Expensive repairs or time-consuming claims settlements are also unpleasant consequences.

When making decisions about how to protect devices, you should never exclude the use of type 3 device protection.

More information on this topic:
phoe.co/spd-building



Increased safety for your home

Type 3 device protection with a compact design

With the type 3 device protection of the BLOCKTRAB product family, you can provide hidden protection for end devices. The BLT-T3 is installed in device sockets, cable ducts, and underfloor systems. The BLT-SKT is installed on the rear of standard sockets. The connected loads remain in operation even in the event of an overload.



"Hidden" surge protection for permanent installations

Type 3 device protection as an intermediate plug



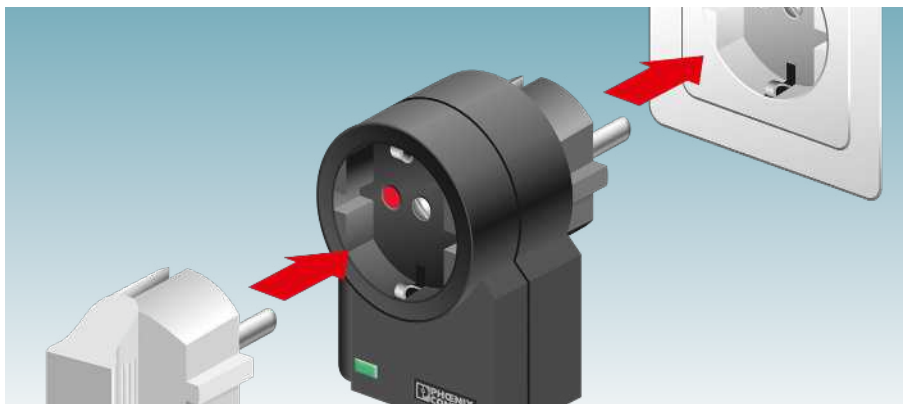







The adapters for mains sockets are ideal for retrofitting surge protection upstream of electronic end devices. A green LED indicates the surge protection function of the protective device. Optimum protection is provided for all connected loads. Moreover, intermediate plugs with interface protection are available. These simultaneously protect the power supply and another interface, such as a TV or telecommunications (TAE) interface, against surge voltages.













Easy retrofitting with intermediate plugs

Protection directly at the end device



Type 3 device protection with Push-in connection



	 COMPLETE line					
Number of positions		2-pos.	2-pos.	2-pos.	2-pos.	2-pos.
Nominal voltage		24 V AC (TN-S)	60 V AC (TN-S)	120 V AC (TN-S) 120 V AC (TT)	240 V AC (TN-S) 240 V AC (TT)	24 V DC
Type in accordance with IEC		T3	T3	T2 / T3	T2 / T3	T3
Maximum continuous operating voltage U_c		34 V AC	80 V AC	150 V AC	264 V AC	30 V DC
Voltage protection level		≤ 0.2 kV (L-N) ≤ 0.6 kV (N-PE)	≤ 0.48 kV (L-N) ≤ 0.8 kV (N-PE)	≤ 0.75 kV (L-N) ≤ 0.85 kV (N-PE)	≤ 1.25 kV (L-N) ≤ 1.4 kV (N-PE)	≤ 0.09 kV ($U_{oc} = 2$ kV) (DC-DC) ≤ 0.7 kV (DC-PE)
Max. backup fuse F2		32 A (gG / B / C)	32 A (gG / B / C)	32 A (gG / B / C)	32 A (gG / B / C)	6 A (gG)
Approvals						
Nominal discharge current		1 kA	2 kA	5 kA	5 kA	1 kA
Combined surge		2 kV	4 kV	6 kV	6 kV	2 kV (2 Ω)
Type		PLT-SEC-T3-24-FM-PT	PLT-SEC-T3-60-FM-PT	PLT-SEC-T3-120-FM-PT	PLT-SEC-T3-230-FM-PT	TTC-6P-T3-24DC-PT-I
Item number		2907925	2907926	2907927	2907928	1027586

Type 3 device protection with screw connection



	 COMPLETE line					
Number of positions		2-pos.	2-pos.	2-pos.	2-pos.	2-pos.
Nominal voltage		24 V AC (TN-S)	60 V AC (TN-S)	120 V AC (TN-S) 120 V AC (TT)	240 V AC (TN-S) 240 V AC (TT)	24 V DC
Type in accordance with IEC		T3	T3	T2 / T3	T2 / T3	T3
Maximum continuous operating voltage U_c		34 V AC	80 V AC	150 V AC	264 V AC	30 V DC
Voltage protection level		≤ 0.2 kV (L-N) ≤ 0.6 kV (N-PE)	≤ 0.48 kV (L-N) ≤ 0.8 kV (N-PE)	≤ 0.75 kV (L-N) ≤ 0.85 kV (N-PE)	≤ 1.25 kV (L-N) ≤ 1.4 kV (N-PE)	≤ 0.09 kV ($U_{oc} = 2$ kV) (DC-DC) ≤ 0.7 kV (DC-PE)
Max. backup fuse F2		32 A (gG / B / C)	32 A (gG / B / C)	32 A (gG / B / C)	32 A (gG / B / C)	6 A (gG)
Approvals						
Nominal discharge current		1 kA	2 kA	5 kA	5 kA	1 kA
Combined surge		2 kV	4 kV	6 kV	6 kV	2 kV (2 Ω)
Type		PLT-SEC-T3-24-FM-UT	PLT-SEC-T3-60-FM-UT	PLT-SEC-T3-120-FM-UT	PLT-SEC-T3-230-FM-UT	TTC-6P-T3-24DC-UT-I
Item number		2907916	2907917	2907918	2907919	1027584

Protection directly at the end device

Permanent installation on a socket		
		
Number of positions	2-pos.	2-pos.
Nominal voltage	230 V AC (TN-S) 230 V AC (TT)	230 V AC (TN-S) 230 V AC (TT)
Type in accordance with IEC	T3	T3
Maximum continuous operating voltage U_c	255 V AC	255 V AC
Voltage protection level	≤ 1.5 kV	≤ 1.5 kV
Max. backup fuse F2	16 A (MCB B)	16 A (MCB B)
Combined surge	6 kV	6 kV
Type	BLT-SKT-230-A	BLT-T3-230-A
Item number	1038842	1038841

Installation in cable ducts		
		
Number of positions	2-pos.	2-pos.
Nominal voltage	230/400 V AC (TN-S) 230/400 V AC (TT)	230/400 V AC (TN-S) 230/400 V AC (TT)
Type in accordance with IEC	T3	T3
Maximum continuous operating voltage U_c	275 V AC (L-N) 440 V AC (N-PE)	275 V AC (L-N) 440 V AC (N-PE)
Voltage protection level	≤ 1.3 kV (L-N) ≤ 1.5 kV (N-PE)	≤ 1.3 kV (L-N) ≤ 1.5 kV (N-PE)
Max. backup fuse F2	16 A (MCB B)	16 A (MCB B)
Approvals	ERC	ERC
Nominal discharge current	3 kA	3 kA
Combined surge	6 kV	6 kV
Type	BT-1S-230AC/A	BT-1S-230AC/O
Item number	2803409	2800625



Protection directly at the end device

Intermediate plugs		
		
Number of positions	2-pos.	2-pos.
Nominal voltage	230/400 V AC (TN/TT)	230/400 V AC (TN/TT)
Type in accordance with IEC	T3	T3
Maximum continuous operating voltage U_c	275 V AC (L-N) 360 V AC (N-PE)	275 V AC (L-N) 360 V AC (N-PE)
Voltage protection level	≤ 1.5 kV	≤ 1.5 kV
Max. backup fuse F2	16 A (gG / B / C)	16 A (gG / B / C)
Approvals	ERC	ERC
Combined surge	6 kV	6 kV
Type	MNT-1 D	MNT-1 D/WH
Item number	2882200	2882213

Intermediate plugs for TV SAT		
		
Number of positions	2-pos.	2-pos.
Nominal voltage	230/400 V AC (TN/TT)	230/400 V AC (TN/TT)
Type in accordance with IEC	T3	T3
Maximum continuous operating voltage U_c	275 V AC (L-N) 360 V AC (N-PE)	275 V AC (L-N) 360 V AC (N-PE)
Voltage protection level	≤ 1.5 kV	≤ 1.5 kV
Max. backup fuse F2	16 A (gG / B / C)	16 A (gG / B / C)
Approvals	ERC	ERC
Combined surge	6 kV	6 kV
Type	MNT-TV-SAT D	MNT-TV-SAT D/WH
Item number	2882284	2882297

Protection directly at the end device

Intermediate plugs for TAE		
		
Number of positions	2-pos.	2-pos.
Nominal voltage	230/400 V AC (TN/TT)	230/400 V AC (TN/TT)
Type in accordance with IEC	T3	T3
Maximum continuous operating voltage U_c	275 V AC (L-N) 360 V AC (N-PE)	275 V AC (L-N) 360 V AC (N-PE)
Voltage protection level	≤ 1.5 kV	≤ 1.5 kV
Max. backup fuse F2	16 A (gG / B / C)	16 A (gG / B / C)
Approvals	ERC	ERC
Combined surge	6 kV	6 kV
Type	MNT-TAE D	MNT-TAE D/WH
Item number	2882381	2882394

Surge protection for AC applications, PCB mounting		
		
Nominal voltage	230 V AC (TN) 230 V AC (TT)	230 V AC (TN) 230 V AC (TT)
Type in accordance with IEC	T2	T2
Maximum continuous operating voltage U_c	350 V AC	350 V AC
Voltage protection level	≤ 1.5 kV	≤ 2.5 kV (L-N) ≤ 1.8 kV (N-PE)
Max. backup fuse F2	16 A AC (MCB B / general purpose)	63 A (MCB C)
Nominal discharge current	5 kA	20 kA
Type	PRT-1S-350/5S	PRT-1S-350/20/R
Item number	2908551	2905977

Surge protection for measurement and control technology

The interfaces in measurement and control technology are particularly sensitive. Even low surge voltages have the potential to disrupt smooth operation of the building control technology, production, and process technology. Surge protection systems specially tailored to the requirements enable the interference-free transmission of signals.

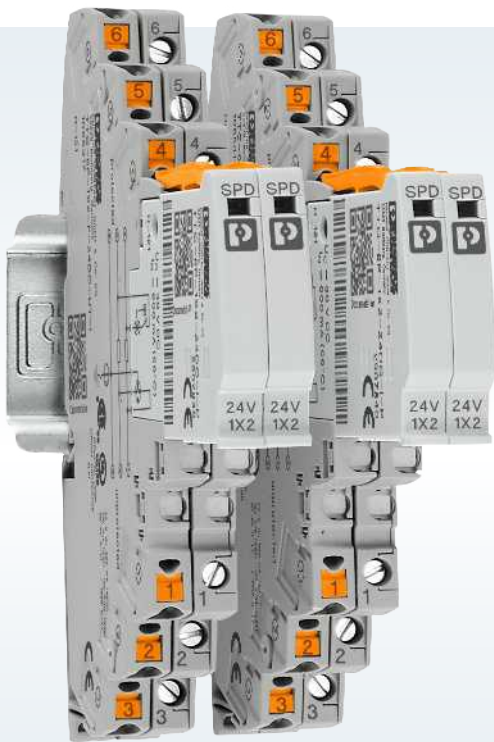

Compact for every application

TERMITRAB complete – surge protection with an overall width starting at 3.5 mm for applications in the extra-low-voltage range with a selectable range of functions.

More information starting on page 44



Intelligent and predictive

PLUGTRAB PT-IQ – surge protection with intelligent monitoring of applications in the extra-low-voltage range with three-stage function indicator.

More information starting on page 54

	TERMITRAB complete	PLUGTRAB PT-IQ	CLIXTRAB	SURGETRAB
Mounting type	DIN rail	DIN rail	DIN rail	Can be screwed onto field device
Overall width	3.5 mm / 6.2 mm	17.5 mm	10.3 mm	1/2" / 3/4", M20
Connection technology	Push-in / screw	Push-in / screw	Push-in	Cables
Pluggable / not pluggable	Yes / Yes	Yes / No	Yes / No	-
Status indicator	2-stage, mechanical	3-stage, LED	2-stage, mechanical	No
Remote signaling	Optional	Yes	Optional	No
Can be tested with CHECKMASTER 2	Yes	Not necessary	Yes	No
Intrinsically safe versions (Ex i)	Yes	Yes	No	Yes



Space-saving for high signal voltages

CLIXTRAB – the combination of surge protection and terminal block for signal voltages up to 230 V AC/DC with function indicator.

More information starting on page 60



Robust for applications in the field

SURGETRAB – surge protection for easy mounting on field devices.

More information starting on page 64

Typical applications for MCR products

Process technology

Transient overvoltages are often indirectly coupled into copper cables, e.g. when lightning strikes in the vicinity. These cause defects in electronic MCR systems in process technology systems, which can lead to system downtime and costly repair work. Surge protection designed specifically to protect your system against surge voltages is always recommended. This ensures that your system is in stable condition over the long term. The comprehensive portfolio includes an optimized circuit for every application. The surge protective devices feature a variety of additional functions that make maintenance easier in large processing systems. Products with an integrated

disconnect knife enable separation between the controller and the field cable, for example. This allows maintenance work and measurements to be carried out easily. Product families for potentially explosive areas and for direct installation on measuring heads complete the portfolio.



Stable processes even in extreme weather situations

Wind turbine generators

Maximum system availability, safe operation, and efficient maintenance are required to optimize the energy yield from wind turbine generators. Surge protection for MCR technology helps you in reaching these goals. Wind turbine generators are installed in exposed locations. They are often the tallest structures in the area, so they are hit by many lightning strikes. A broad portfolio of surge protective devices makes it possible to protect the high number of sensors in a wind turbine generator. System availability is optimized. This provides optimum protection of systems for blade load monitoring, wind measurement, speed measurement, and condition monitoring of

the system. State monitoring with a remote signaling option for surge protective devices is available to ensure efficient maintenance. Even the harsh ambient conditions in which a wind turbine generator operates cannot impede optimal protection.



Protected signal circuits at lofty heights

Water and wastewater treatment

High system availability and a comprehensive maintenance concept are crucial for state-of-the-art system operation in water and wastewater treatment. Using surge protection for the MCR technology is recommended for ensuring this level of system availability. Moreover, the various surge protective devices feature a variety of different additional functions. This means, for example, that the surge protection state can be continuously monitored in a central control room using remote signaling options. This ensures that less work is required in the maintenance of outdoor structures such as groundwater wells or wastewater pumping stations. Moreover, it

is possible to use products with integrated knife disconnection to simplify the maintenance and diagnostics of connected field devices. Even harsh ambient conditions are no challenge. The portfolio of surge protective devices for MCR technology features solutions for safeguarding various interfaces in the water and wastewater treatment industry.



Clean water with high system availability

Photovoltaics

Data networking is playing an ever increasing role in photovoltaic systems. Due to the decentral structure in ground-mounted systems, transmission systems are particularly exposed to the dangers of coupled, transient overvoltages. Sensors, data loggers, and transmission systems ensure the comprehensive, split-second recording of PV performance data and meteorological measured values. Permanent availability is prerequisite for the stable operation of such a system. It is necessary to use special surge protection products to protect the copper-based transmission systems against transient surge voltages during storms. In the worst case, a transient

overvoltage can cause a complete failure of the system monitoring system if control and data cables are unprotected. Depending on requirements, our comprehensive portfolio includes the perfect surge protective devices to protect measurement, control, and data cables in photovoltaic projects.



Prevention of complete PV facility failures

Railway infrastructure

Control command and signaling technology is the foundation for safe and reliable railway operations. Secured rail routes are set up in the signal boxes. Switches are set and the corresponding signals are switched. The external signal technology systems do not just output signals. These often include other components as well, such as axle counters and track vacancy reporting devices, which are necessary for smooth railway operations. Overvoltages caused by atmospheric disturbances or sparkovers on the contact wires, for example, can occur at any time in the extensive rail network. Therefore, appropriate lightning and surge protection for the measurement and

frame data from external signal technology systems and the controllers in the signal box against transient coupling in the signal lines is essential. Railroad technology often uses high signal voltages for control, so the surge protective devices of the CLIXTRAB product family provide ideal protection for this type of application.



Modern railway infrastructure with surge protection

Transportation infrastructure

Transient overvoltages caused by lightning or by switching operations can damage devices and installations or cause them to fail completely. Although they run underground, tunnels are not automatically protected from these events. A large amount of safety equipment is installed in every tunnel. Starting with ventilation and air exhaust systems, through emergency lighting, right through to the controllers for variable traffic signs, operation of the equipment must be assured. A failure due to a surge voltage will result in the tunnel being closed for repairs. Therefore, each interface needs appropriate protection. Our broad range of products features

the perfect solution for every application: for example, surge protection for fast data communication and intelligent surge protection for the MCR technology. In order to guarantee uninterrupted protection for the tunnel, intelligent components such as the PLUGTRAB PT-IQ issue a signal as soon as the power limit is reached. This enables you to replace the surge protective device before a failure occurs, meaning that the tunnel continues to operate unimpeded.



Safely through the tunnel thanks to surge protection

Surge protection for measurement and control technology

The narrowest surge protection solution for all MCR applications

TERMITRAB complete is the world's narrowest surge protection solution for MCR technology. Starting from an overall width of just 3.5 mm, the product family provides you with a complete system with many advantages. Depending on your requirements, choose from simple protective devices in a slim design to items with comprehensive functions.

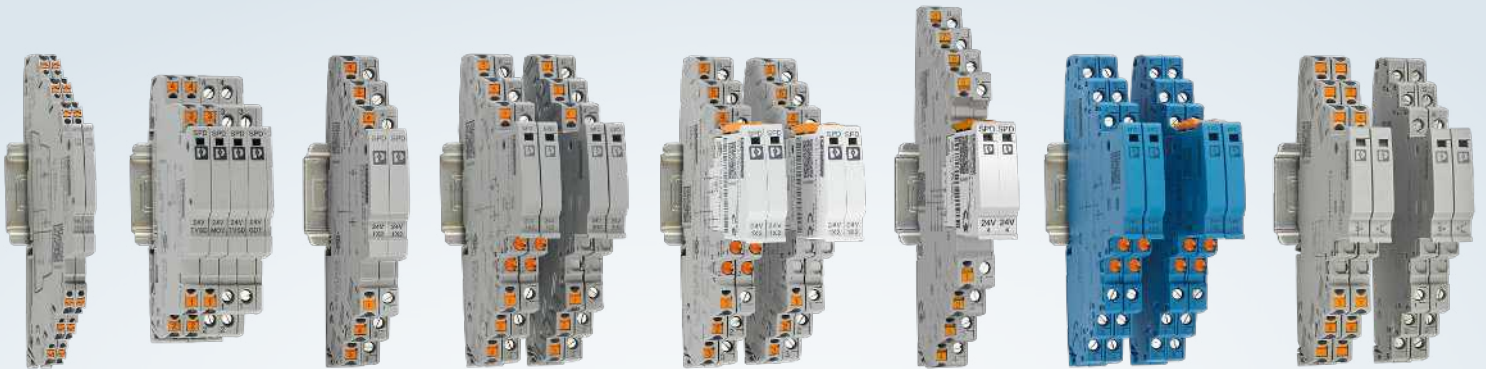

Your advantages

- ✓ Space-saving with the world's narrowest surge protection, starting from 3.5 mm
- ✓ Stay informed at all times with the integrated status indicator and remote signaling option
- ✓ Ideal protection for your application with the tailored portfolio

TERMITRAB complete – compact for every application

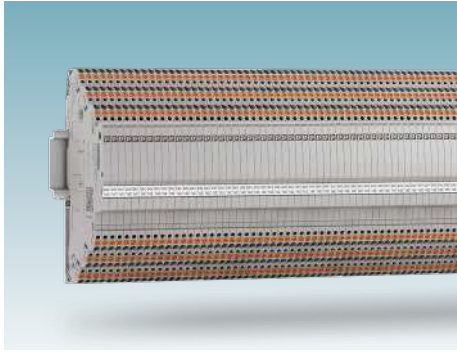

Extremely narrow overall width

Starting at an overall width of just 3.5 mm – protect up to 572 signals across 1 m with the ultra-slim overall width.

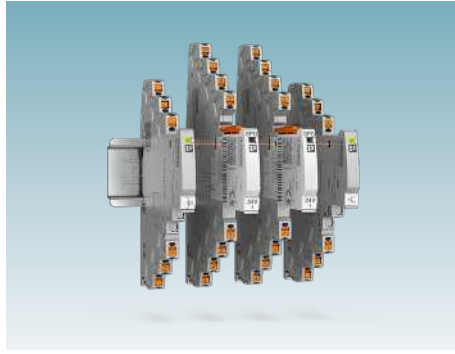

Status indicator and remote signaling

Always know what is going on. With a mechanical status indicator on the protective device or via optional remote signaling modules in the control room.



Tailored portfolio

With TERMITRAB complete, you will find the ideal surge protective device for your specific requirements.

Testing and maintenance made easy

TERMITRAB complete features versions with integrated knife disconnection. This saves even more installation space. The disconnection option can be used on the top two terminal levels. For example, insulation measurements can be carried out on the cables without the voltage-limiting components distorting the test results.

Pluggable surge protective devices can be replaced during maintenance without having to access the wiring. The measuring signal is not interrupted, which means that errors are not generated in the measurement results. Use CHECKMASTER 2 to test the plugs quickly and easily as part of regular

lightning protection tests in accordance with IEC 62305-3. This enables standardized, simple documentation of test results and predictive device maintenance.

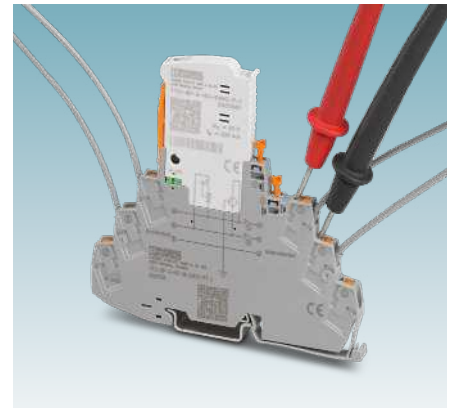



Testing directly at the protective device

Item designation key







TTC-6P-1X2-F-M-24DC-PT-I	Example	Further options
Indicator (status indicator)	Indicator (status indicator)	Without indicator (status indicator)
Push-in	Push-in	Universal terminal (screw)
24 V DC	24 V DC	5 V DC / 12 V DC / 48 V DC / 60 V DC / 120 V AC
Knife disconnection	Knife disconnection	Ex applications
Floating	Floating	Directly grounded
1X2 ONEPAIR (isolated)	1X2 ONEPAIR (isolated)	2X1 / 2 / 2-HC / 3 / 3-HF / 4 / TELE
Pluggable	Pluggable	One-piece
6 mm	6 mm	3.5 mm
TERMITRAB complete	TERMITRAB complete	

TERMITRAB complete – compact for every application

Basic protection for isolated signal circuits and signals with a common reference potential





		
Pluggable	No	No
Knife disconnection	No	No
Number of signal wires	3	2
Rated current	250 mA (70°C)	
Maximum continuous operating voltage U_c	30 V DC / 21 V AC	
IEC test classification	C1, C2, C3, D1	
Pulse discharge current I_{imp} (10/350) μ s	0.5 kA	
Total discharge current I_{total} (8/20) μ s	10 kA	
Resistance per path	2.2 Ω \pm 10%	
Push-in connection	TTC-3-2X1-24DC-PT 2907326	TTC-3-1X2-24DC-PT 2907325

Isolated signal circuits, directly grounded

 				
Pluggable	Yes	Yes	No	No
Knife disconnection	Yes	No	Yes	No
Number of signal wires	2	2	2	2
Rated current	600 mA (56°C)		600 mA (40°C)	
Maximum continuous operating voltage U_c	30 V DC / 21 V AC			
IEC test classification	C1, C2, C3, D1			
Pulse discharge current I_{imp} (10/350) μ s	0.5 kA			
Total discharge current I_{total} (8/20) μ s	10 kA			
Resistance per path	1.65 Ω \pm 20%			
Push-in connection	TTC-6P-1X2-M-24DC-PT-I 2906750	TTC-6P-1X2-24DC-PT-I 2906815	TTC-6-1X2-M-24DC-PT-I 2906726	TTC-6-1X2-24DC-PT 2906804
Screw connection	TTC-6P-1X2-M-24DC-UT-I 2906738	TTC-6P-1X2-24DC-UT-I 2906809	TTC-6-1X2-M-24DC-UT-I 2906713	TTC-6-1X2-24DC-UT 2906798

TERMITRAB complete – compact for every application

Isolated signal circuits, indirectly grounded

 			
	Yes	Yes	No
Pluggable	Yes	No	Yes
Knife disconnection	Yes	No	Yes
Number of signal wires	2	2	2
Rated current	600 mA (56°C)		600 mA (40°C)
Maximum continuous operating voltage U_c	30 V DC / 21 V AC		
IEC test classification	C1, C2, C3, D1		
Pulse discharge current I_{imp} (10/350) μ s	0.5 kA		
Total discharge current I_{total} (8/20) μ s	10 kA		
Resistance per path	1.65 Ω \pm 20%		
Push-in connection	TTC-6P-1X2-F-M-24DC-PT-I 2906790	TTC-6P-1X2-F-24DC-PT-I 1065318	TTC-6-1X2-F-M-24DC-PT-I 2906772
Screw connection	TTC-6P-1X2-F-M-24DC-UT-I 2906781	TTC-6P-1X2-F-24DC-UT-I 1065317	TTC-6-1X2-F-M-24DC-UT-I 2906764

The right product is just two clicks away

TERMITRAB complete offers over 100 products with different circuit and voltage variants. Various connection technologies and product features complete the portfolio. This variety provides a solution for virtually all applications in MCR technology. The configurator helps you to keep track of everything. In just two clicks, you can navigate to a selection of products that offer optimum protection for your application. First, select the application or interface that you want to protect. Then select the desired design. You then also have the option to define additional features on the selection page. If a suitable TERMITRAB complete product is not available for your application, use the advanced search to find more items.

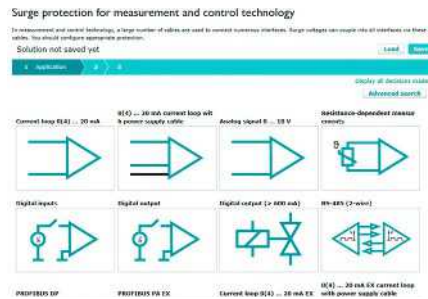

Step 1:
Select the application or interface

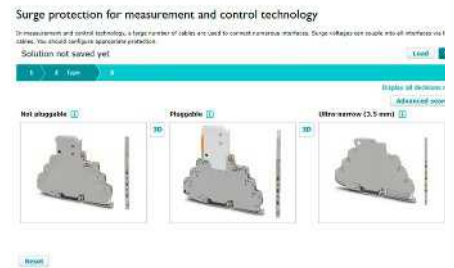









Step 2:
Select the design

For further information on the online configurator, simply enter the web code in the search field on our website.

 Web code: #1389





TERMITRAB complete – compact for every application

Common reference potential, directly grounded				
 COMPLETE line				
Pluggable	Yes	Yes	No	No
Knife disconnection	Yes	No	Yes	No
Number of signal wires	3	3	3	3
Rated current	600 mA (56°C)		600 mA (40°C)	
Maximum continuous operating voltage U_c	30 V DC / 21 V AC			
IEC test classification	C1, C2, C3, D1			
Pulse discharge current I_{imp} (10/350) μ s	0.5 kA			
Total discharge current I_{total} (8/20) μ s	10 kA			
Resistance per path	1.65 Ω \pm 20%			
Push-in connection	TTC-6P-2X1-M-24DC-PT-I 2906753	TTC-6P-2X1-24DC-PT-I 2906816	TTC-6-2X1-M-24DC-PT-I 2906729	TTC-6-2X1-24DC-PT 2906805
Screw connection	TTC-6P-2X1-M-24DC-UT-I 2906741	TTC-6P-2X1-24DC-UT-I 2906810	TTC-6-2X1-M-24DC-UT-I 2906716	TTC-6-2X1-24DC-UT 2906799

Common reference potential, indirectly grounded			
 COMPLETE line			
Pluggable	Yes	Yes	No
Knife disconnection	Yes	No	Yes
Number of signal wires	3	3	3
Rated current	600 mA (56°C)		600 mA (40°C)
Maximum continuous operating voltage U_c	30 V DC / 21 V AC		
IEC test classification	C1, C2, C3, D1		
Pulse discharge current I_{imp} (10/350) μ s	0.5 kA		
Total discharge current I_{total} (8/20) μ s	10 kA		
Resistance per path	1.65 Ω \pm 20%		
Push-in connection	TTC-6P-2X1-F-M-24DC-PT-I 2906794	TTC-6P-2X1-F-24DC-PT-I 1065320	TTC-6-2X1-F-M-24DC-PT-I 2906776
Screw connection	TTC-6P-2X1-F-M-24DC-UT-I 2906784	TTC-6P-2X1-F-24DC-UT-I 1065319	TTC-6-2X1-F-M-24DC-UT-I 2906767

TERMITRAB complete – compact for every application

For resistance-dependent measurements

 COMPLETE line				
Pluggable	Yes	Yes	Yes	No
Knife disconnection	No	No	No	No
Number of signal wires	4	3	3	2
Rated current	2.5 A (60°C, for insulated systems)	5 A (55°C)		450 mA (80°C)
Maximum continuous operating voltage U_c	36 V DC / 30 V AC	5 V DC / 3 V AC	30 V DC / 21 V AC	
IEC test classification	C1, C2, C3, D1	C1, C2, C3	C1, C2, C3, D1	
Pulse discharge current I_{imp} (10/350) μ s	0.5 kA	-	0.5 kA	
Total discharge current I_{total} (8/20) μ s	10 kA			
Resistance per path	0.03 Ω	<0.1 Ω		≤ 100 m Ω
Push-in connection	TTC-6P-4-24DC-PT-I 1106014	TTC-6P-3-5DC-PT-I 1061385	TTC-6P-3-24DC-PT-I 1061383	TTC-6-2-24DC-PT 2906806
Screw connection	TTC-6P-4-24DC-UT-I 1106013			TTC-6-2-24DC-UT 2906800

Direct and indirect grounding

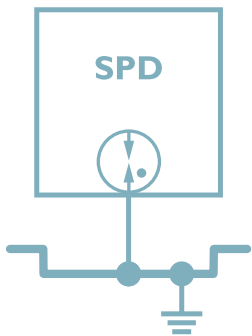

Indirect grounding

For surge protective devices with “F” in the name, the connection terminal blocks for the shield or the reference potential are indirectly connected to the metal mounting foot via a gas discharge tube and thus to the DIN rail.

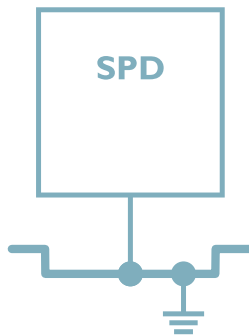





Direct grounding





For surge protective devices without “F” in the name, the connection terminal blocks for the shield or the reference potential are directly connected to the DIN rail via the metal mounting foot.

TERMITRAB complete – compact for every application

For potentially explosive applications with isolated signal circuits







				
		Pluggable	Yes	Yes
Knife disconnection		Yes	No	Yes
Number of signal wires		2	2	2
Rated current		600 mA (40°C)		
Maximum continuous operating voltage U_c		30 V DC		
IEC test classification		C1, C2, C3, D1		
Pulse discharge current I_{imp} (10/350) μ s		0.5 kA		
Total discharge current I_{total} (8/20) μ s		10 kA		
Resistance per path		1.65 Ω \pm 20%		
Screw connection		TTC-6P-1X2-M-EX-24DC-UT-I 2906824	TTC-6P-1X2-EX-24DC-UT-I 1065312	TTC-6-1X2-M-EX-24DC-UT-I 2906820

For potentially explosive applications, up to three signal wires





				
		Pluggable	Yes	Yes
Knife disconnection		No	Yes	Yes
Number of signal wires		3	3	3
Rated current		5 A (55°C)	600 mA (40°C)	
Maximum continuous operating voltage U_c		30 V DC		
IEC test classification		C1, C2, C3, D1		
Pulse discharge current I_{imp} (10/350) μ s		0.5 kA		
Total discharge current I_{total} (8/20) μ s		10 kA		
Resistance per path		<0.1 Ω	1.65 Ω \pm 20%	
Screw connection		TTC-6P-3-EX-24DC-UT-I 1064665	TTC-6P-2X1-M-EX-24DC-UT-I 2906825	TTC-6-2X1-M-EX-24DC-UT-I 2906821

TERMITRAB complete – compact for every application

Signal circuits with high rated current





 				
	Pluggable	Yes	Yes	No
Knife disconnection	Yes	No	Yes	No
Number of signal wires	2	2	2	2
Rated current	6 A (55°C)			
Maximum continuous operating voltage U_c	30 V DC / 21 V AC			
IEC test classification	C1, C2, C3, D1			
Pulse discharge current I_{imp} (10/350) μ s	0.5 kA			
Total discharge current I_{total} (8/20) μ s	5 kA			
Resistance per path	≤ 100 m Ω			
Push-in connection	TTC-6P-2-HC-M-24DC-PT-I 2906755	TTC-6P-2-HC-24DC-PT-I 2906817	TTC-6-2-HC-M-24DC-PT-I 2906731	TTC-6-2-HC-24DC-PT-I 2908439
Screw connection	TTC-6P-2-HC-M-24DC-UT-I 2906743	TTC-6P-2-HC-24DC-UT-I 2906811	TTC-6-2-HC-M-24DC-UT-I 2906719	TTC-6-2-HC-24DC-UT-I 2908438

Single-level protective devices, fine protection with suppressor diode



				
	Pluggable	No	No	No
Knife disconnection	No	No	No	No
Number of signal wires	2	1	2	2
Rated current	10 A (60°C)		6 A (55°C)	
Maximum continuous operating voltage U_c	30 V DC / 21 V AC			15 V DC / 10 V AC
IEC test classification	C3		C1, C3	C1, C2, C3
Total discharge current I_{total} (8/20) μ s	-		1 kA	2 kA
Resistance per path	≤ 100 m Ω			
Direction of action	Line-line	Line-earth ground	Line-earth ground	Line-earth ground
Push-in connection	TTC-6-TVSD-D-24DC-PT-I 2906851	TTC-6-TVSD-C-24DC-PT-I 2906848	TTC-6-2XTVSD-24DC-PT 2906808	TTC-6-2XTVSD-12DC-PT 2906807
Screw connection	TTC-6-TVSD-D-24DC-UT-I 2906834	TTC-6-TVSD-C-24DC-UT-I 2906831		

TERMITRAB complete – compact for every application





Single-level protective devices, medium protection with metal oxide varistor

				
Pluggable	No	No	No	No
Knife disconnection	No	No	No	No
Number of signal wires	2	2	1	1
Rated current	10 A (60 °C)			
Maximum continuous operating voltage U_c	30 V DC / 21 V AC	150 V DC / 150 V AC	30 V DC / 21 V AC	150 V DC / 150 V AC
IEC test classification	C1, C2, C3			
Resistance per path	$\leq 100 \text{ m}\Omega$			
Direction of action	Line-line		Line-earth ground	
Push-in connection	TTC-6-MOV-D-24DC-PT-I 2906859	TTC-6-MOV-D-120AC-PT-I 1109689	TTC-6-MOV-C-24DC-PT-I 2906854	TTC-6-MOV-C-120AC-PT-I 2906858
Screw connection	TTC-6-MOV-D-24DC-UT-I 2906841	TTC-6-MOV-D-120AC-UT-I 1109673	TTC-6-MOV-C-24DC-UT-I 2906837	TTC-6-MOV-C-120AC-UT-I 2906840

Single-level protective devices, coarse protection with gas discharge tube

	
Pluggable	No
Knife disconnection	No
Number of signal wires	1
Rated current	1 A DC (60 °C) / 2 A AC (60 °C)
Maximum continuous operating voltage U_c	28 V DC / 36 V AC
IEC test classification	C1, C2, C3, D1
Pulse discharge current I_{imp} (10/350) μs	0.5 kA
Resistance per path	$\leq 100 \text{ m}\Omega$
Direction of action	Line-earth ground
Push-in connection	TTC-6-GDT-C-24AC-PT-I 2906860
Screw connection	TTC-6-GDT-C-24AC-UT-I 2906842

TERMITRAB complete – compact for every application

Remote signaling sets and modules				
COMPLETE line				
Connection technology	Push-in connection	Screw connection	Push-in connection	new
Brief description	Remote signaling set		Remote signaling module – receiver	Remote signaling module – transmitter
Product characteristic	Transmission and receiver module for remote signaling of TTC-6...-I products		-	
Type	TTC-6-FMRS-PT	TTC-6-FMRS-UT	TTC-6-FMRX-PT	TTC-6-FMTX-PT
Item number	2907811	2907810	1193571	1193565

Surge protection for measurement and control technology

Intelligent and predictive systematic surge protection

PLUGTRAB PT-IQ is a system comprising a supply and remote signaling module and the actual surge protective devices with a three-level status indicator. One module supplies the protective devices and provides the group remote signaling for up to 28 protective modules. Each voltage-limiting component is intelligently monitored.



Your advantages

- ✓ Preventive replacement of protective devices with pre-existing damage with multi-stage display and remote signaling
- ✓ Direct installation in Ex Zone 2 with protective devices for intrinsically safe circuits up to Ex Zone 0
- ✓ Rapid and error-free installation with DIN rail connectors and coded plugs

PLUGTRAB PT-IQ – intelligent and predictive



Visual control function

The status at a glance: green = everything ok, yellow = replacement recommended, red = replacement required

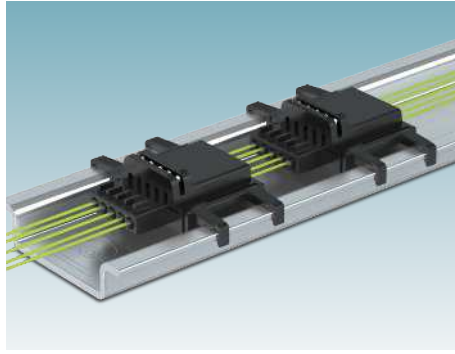

Permanent installation

Power supply and status information via individual DIN rail connectors that can be extended to form a bus.

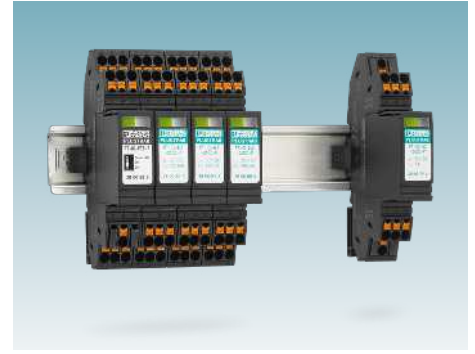

Easy to extend

A controller supplies up to 28 protective modules and collects the status of the protective devices.

Always know what is going on.

The protective devices of the PLUGTRAB range feature practical functions. The protective devices are pluggable, which means they can be quickly replaced when necessary, even when the system is in operation.

PLUGTRAB PT-IQ provides multi-stage monitoring of the protective devices and group messages via the controller. A yellow status signal indicates that the performance limit has been reached, as a result of frequent surge voltages. The protective devices are still functional. Your system continues to be protected. However, to avoid unnecessary service operations, a

replacement is recommended. Remote signaling enables you to check how well your system is being protected at any time and place.



PLUGTRAB PT-IQ with three-level status indicator

Item designation key

PT-IQ-1X2+F- 24DC-PT

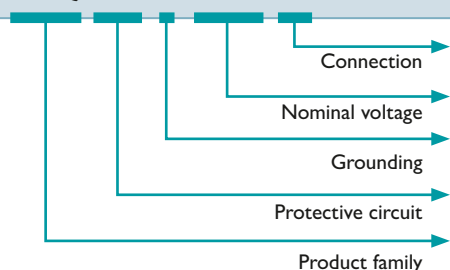

Example	Further options
Push-in	Universal terminal (screw)
24 V DC	5 V DC / 12 V DC / 48 V DC / 60 V DC
Floating (indirectly grounded)	Directly grounded
1X2 ONEPAIR (isolated)	2X1 / 2 / 2-HC / 3 / 3-HF / 5-HF / TELE
PLUGTRAB-IQ	

PLUGTRAB PT-IQ – intelligent and predictive

Isolated signal circuits, directly grounded		
		
Number of signal wires	2	4
Rated current	1000 mA (40°C)	700 mA (50°C)
Maximum continuous operating voltage U_c	30 V DC / 21 V AC	
IEC test classification	C1, C2, C3, D1	
Pulse discharge current I_{imp} (10/350) μ s	2.5 kA	
Total discharge current I_{total} (8/20) μ s	20 kA	
Resistance per path	1.2 Ω \pm 5%	
Push-in connection	PT-IQ-1X2-24DC-PT 2801255	PT-IQ-2X2-24DC-PT 2801263
Screw connection	PT-IQ-1X2-24DC-UT 2800976	PT-IQ-2X2-24DC-UT 2800980

Isolated signal circuits, indirectly grounded		
		
Number of signal wires	2	4
Rated current	1000 mA (40°C)	700 mA (50°C)
Maximum continuous operating voltage U_c	30 V DC / 21 V AC	
IEC test classification	C1, C2, C3, D1	
Pulse discharge current I_{imp} (10/350) μ s	2.5 kA	
Total discharge current I_{total} (8/20) μ s	20 kA	
Resistance per path	1.2 Ω \pm 5%	
Push-in connection	PT-IQ-1X2+F-24DC-PT 2801256	PT-IQ-2X2+F-24DC-PT 2801264
Screw connection	PT-IQ-1X2+F-24DC-UT 2800977	PT-IQ-2X2+F-24DC-UT 2800981

PLUGTRAB PT-IQ – intelligent and predictive

Common reference potential, directly grounded





Number of signal wires	3	5
Rated current	1000 mA (40°C)	700 mA (50°C)
Maximum continuous operating voltage U_c	30 V DC / 21 V AC	
IEC test classification	C1, C2, C3, D1	
Pulse discharge current I_{imp} (10/350) μ s	2.5 kA	
Total discharge current I_{total} (8/20) μ s	20 kA	
Resistance per path	1.2 Ω \pm 5%	
Push-in connection	PT-IQ-2X1-24DC-PT 2801247	PT-IQ-4X1-24DC-PT 2801271
Screw connection	PT-IQ-2X1-24DC-UT 2800787	PT-IQ-4X1-24DC-UT 2800982



Common reference potential, indirectly grounded





Number of signal wires	3	5
Rated current	1000 mA (40°C)	700 mA (50°C)
Maximum continuous operating voltage U_c	30 V DC / 21 V AC	
IEC test classification	C1, C2, C3, D1	
Pulse discharge current I_{imp} (10/350) μ s	2.5 kA	
Total discharge current I_{total} (8/20) μ s	20 kA	
Resistance per path	1.2 Ω \pm 5%	
Push-in connection	PT-IQ-2X1+F-24DC-PT 2801248	PT-IQ-4X1+F-24DC-PT 2801272
Screw connection	PT-IQ-2X1+F-24DC-UT 2800788	PT-IQ-4X1+F-24DC-UT 2800983

PLUGTRAB PT-IQ – intelligent and predictive

For potentially explosive applications		
		
Number of signal wires	2	4
Rated current	350 mA	
Maximum continuous operating voltage U_c	30 V DC / 21 V AC	
IEC test classification	C1, C2, C3, D1	
Pulse discharge current I_{imp} (10/350) μ s	2 kA	
Total discharge current I_{total} (8/20) μ s	20 kA	
Resistance per path	1.2 Ω \pm 5%	
Screw connection	PT-IQ-1X2-EX-24DC-UT 2801512	PT-IQ-2X2-EX-24DC-UT 2801513

Accessories: partition plates		
		
Product type	Partition plate	
Description	Partition plate for NS 35/7,5 DIN rails	Partition plate for NS 35/7,5 isolated DIN rails (DIN rail is isolated via the "AB/NS" support bracket)
Type	PT-IQ-EX-L-PP	PT-IQ-EX-H-PP
Item number	2905023	2905024

PLUGTRAB PT-IQ – intelligent and predictive

Supply and remote signaling modules		
		
Connection technology	Screw connection	Push-in connection
Type	PT-IQ-PTB-UT	PT-IQ-PTB-PT
Item number	2800768	2801296

Surge protection for measurement and control technology

Surge protection and terminal block space-saving for high signal voltages

The combination of terminal block and surge protection plug provides safe and space-saving protection for your system. Comprehensive diagnostic and remote signaling options enable easy maintenance. The powerful protective circuit featuring integrated overload protection provides superior system availability.



Your advantages

- ✓ Easy installation with Push-in terminal blocks with pluggable surge protection
- ✓ High system availability thanks to a high-performance protective circuit with integrated overload protection
- ✓ Quick and easy diagnostics with optional remote signaling for integration into digital infrastructures

CLIXTRAB – space-saving for high signal voltages

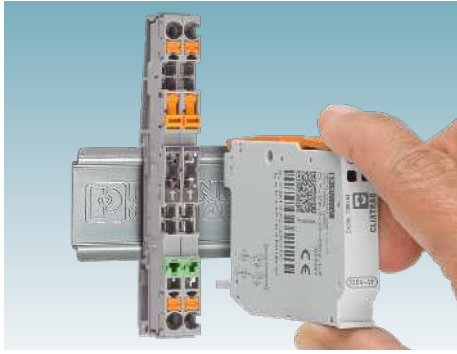

Easy handling

Easy installation with the combination of Push-in terminal blocks and pluggable surge protection.

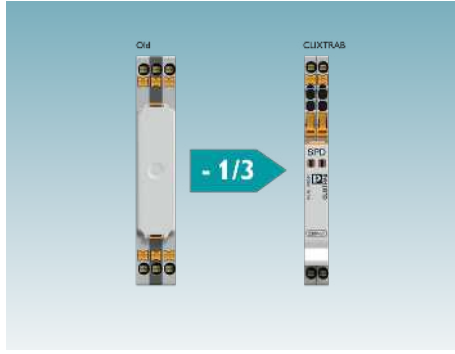

Narrow overall width

Three become two. Use just two terminal blocks to protect two signal paths in an overall width of 10.3 mm.



Fast error identification

Rapid diagnostics with mechanical status indicator and optional remote signaling for integration into digital infrastructures.

Overload protection and remote signaling

CLIXTRAB features a mechanical disconnect device as overload protection. In the event of overload, the device ensures that faulty components are disconnected from the mode of protection – without auxiliary energy. It is easy to identify faulty protective plugs, as the overload protection is connected to the visual status indicator. Visual remote signaling is also possible in addition to indication on the plug. The optional remote signaling modules simplify error diagnostics, as regular on-site testing is not possible for all components, especially in distributed structures. Here, the status of the surge protective devices is transferred to subsequent systems via a floating contact.

Monitoring is easily incorporated in the control center technology and this transfers the status to the control room. Targeted maintenance can be performed easily and efficiently.

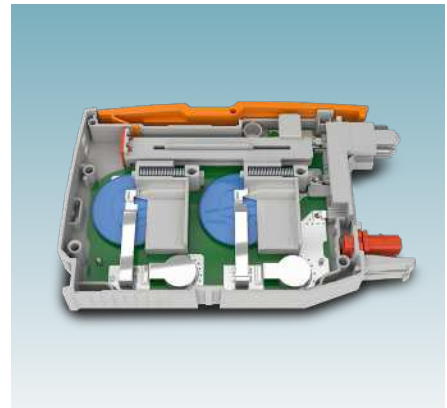

Mechanical disconnect device for permanent availability



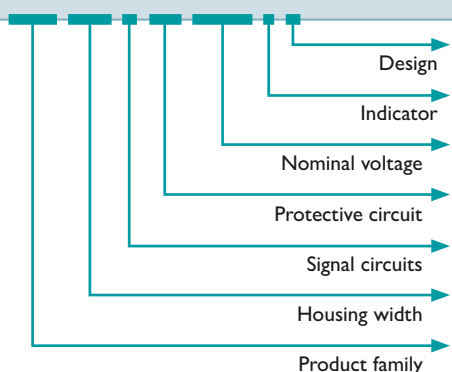

Item designation key



CLT-10P/2-VF-230V-I-P



Example	Further options
Plug	-
With indicator (status indicator)	-
230 V	12 V DC / 24 V DC / 60 V DC
VF	2
2-wire	4-wire
10 mm, pluggable	20 mm, pluggable
CLIXTRAB	



CLIXTRAB – space-saving for high signal voltages

Protective plugs			
			
Nominal voltage	12 V DC new	24 V DC new	60 V DC new
Type in accordance with IEC	C1, C2, C3, D1		
Maximum continuous operating voltage U_c	15 V DC / 10 V AC	30 V DC / 21 V AC	75 V DC / 53 V AC
Rated current	600 mA (80°C)	200 mA (80°C)	
Total discharge current I_{total} (8/20) μ s	10 kA		
Number of disconnect terminal blocks needed	2		
Type	CLT-10P/2-2-12V-I-P	CLT-10P/2-2-24V-I-P	CLT-10P/2-2-60V-I-P
Item number	1088569	1088570	1088573



Protective plugs for high nominal voltage		
		
Nominal voltage	240 V AC new	
Type in accordance with IEC	C1, C2, C3, D1	
Maximum continuous operating voltage U_c	230 V DC / 264 V AC	
Rated current	10 A AC (80°C / 10 A AC C) / 6 A DC (80°C / 6.3 A DC F) / 10 A DC (80°C / 10 A DC D01 gR)	
Total discharge current I_{total} (8/20) μ s	6 kA	12 kA
Number of disconnect terminal blocks needed	2	4
Type	CLT-10P/2-VF-230V-I-P	CLT-20P/4-VF-230V-I-P
Item number	1088564	1088567

CLIXTRAB – space-saving for high signal voltages

Base element for protective plugs

		
Description	Disconnect terminal block new	End cover new
Nominal current I_N	20 A	-
Nominal voltage U_N	400 V	-
Cross-section range	0.14 mm ² ... 4 mm ² / 26 ... 12	-
DIN rail type	NS 35/7.5 / NS 35/15	-
Connection technology	Push-in connection	-
Number of positions	1-pos.	-
Type	PT 2,5-MT-CLT	D-PT 2,5-MT-CLT
Item number	1087698	1088502

Accessories – remote signaling modules

		
Connection technology	Push-in connection new	
Description	Remote signaling module – receiver	Remote signaling module – transmitter
Type	TTC-6-FMRX-PT	TTC-6-FMTX-PT
Item number	1193571	1193565

Simplify maintenance work

CLIXTRAB includes several features that will make maintenance work much easier. The terminal block's integrated knife disconnection can be used to disconnect the signal circuit without accessing the signal lines. This function is not just useful for maintenance work or troubleshooting, but also during startup. When the knife disconnection is opened, it is very easy to perform a measurement of the operating current or the insulation. Testing the lightning and surge protective devices at regular intervals is not only recommended, but indeed prescribed in many areas of application. Due to the surge protection plug, which can be removed and inserted

without causing any interruption, the signal lines in the terminal block remain untouched. System availability is maintained while the plug is being tested or replaced.

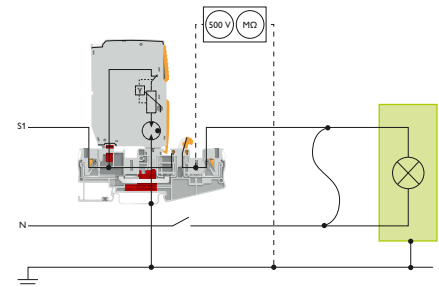

Simple dielectric test

Surge protection for measurement and control technology

Robust surge protection for direct installation on the field device

Screw in, connect, done – SURGETRAB protective devices are designed for all common standard signals that are attached directly to the measuring head via their connecting threads. This mounting type saves time and money, and there is no need for an additional connection box for installing the surge protection.



Your advantages

- ✓ Easy field mounting with standardized thread
- ✓ Versatile in use with universal protective circuit
- ✓ Use under extreme ambient conditions thanks to robust design

SURGETRAB – robust for applications in the field



Installation

Screw in, connect, done – the products feature a connection thread for direct installation on the measuring head.

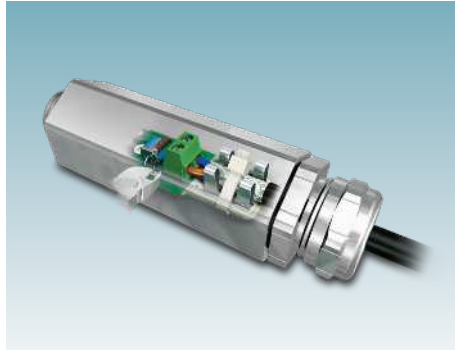

Shield fast connection

The conductor shield can be secured reliably in the shield clamp using a cable tie.



Connection versions

The product family features versions for through-wiring as well as for parallel wiring.

For universal use

This SURGETRAB product family is designed specially for use in the field. Various circuit versions have been optimized for measuring circuits and actuators. Screw connections with metric threads or 1/2" and 3/4" enable use in all field device systems available around the world.

These products are also ideal for harsh industrial environments. A stable hexagonal tube made of V4A stainless steel acts as the IP67 housing.

This means that certain SURGETRAB versions are also suitable for use in explosion-proofed areas.



Item designation key

S-PT-1X2-24DC-1/2

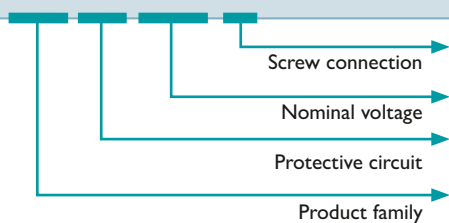

	Example	Further options
	1/2"	3/4" / none = metric
	24 V DC	48 V DC
	1X2 ONEPAIR (isolated)	2X / 4 / for Ex areas
	SURGETRAB	

SURGETRAB – robust for applications in the field

Isolated signal circuits, directly grounded



Number of signal wires	2
Rated current	450 mA (55°C)
Maximum continuous operating voltage U_c	40 V DC / 28 V AC
IEC test classification	C1, C2, C3, D1
Max. short-circuit current at the installation location	1 A
Total discharge current I_{total} (8/20) μ s	20 kA
Resistance per path	2.2 Ω \pm 10%
Mounting threads: M20	S-PT-1X2-24DC 2880668
Mounting threads: 1/2"	S-PT-1X2-24DC-1/2" 2882569
Mounting threads: 3/4"	S-PT-1X2-24DC-3/4" 2882598

Isolated signal circuits for potentially explosive application (Ex i)







Number of signal wires	2
Rated current	350 mA (50°C)
Maximum continuous operating voltage U_c	30 V DC / 21 V AC
IEC test classification	C1, C2, C3, D1
Max. short-circuit current at the installation location	350 mA
Resistance per path	2.2 Ω \pm 10%
Mounting threads: M20	S-PT-EX(I)-24DC 2880671
Mounting threads: 1/2"	S-PT-EX(I)-24DC-1/2" 2882572
Mounting threads: 3/4"	S-PT-EX(I)-24DC-3/4" 2882585

SURGETRAB – robust for applications in the field

1
2
3
4
5

Surge protection for measurement and control technology

For potentially explosive applications (Ex i / Ex d)				
				
Number of signal wires	4	2	4	5
Maximum continuous operating voltage U_c	53 V DC / 37 V AC	36 V DC / 25 V AC		
IEC test classification	C1, C2, C3, D1			
Max. short-circuit current at the installation location	1 A (non-Ex) / 500 mA (Ex)			
Total discharge current I_{total} (8/20) μs	20 kA			
Mounting threads: M20	S-PT-2XEX-48DC 2800038	S-PT-EX-24DC 2800034	S-PT-2XEX-24DC 2800040	S-PT-4-EX-24DC 2800036
Mounting threads: 1/2"	S-PT-2XEX-48DC-1/2" 2800039	S-PT-EX-24DC-1/2" 2800035	S-PT-2XEX-24DC-1/2" 2800041	S-PT-4-EX-24DC-1/2" 2800037

Surge protection for information technology

3

Communication via data networks is a part of daily life in all areas of society. The interfaces operate with low signal levels at high frequencies. This makes them particularly sensitive to surge voltages and can lead to the destruction of electronic components in IT systems.



Universal protection for information technology

The DATATRAB DT product family provides surge protection for many applications:

- High-speed networks up to 10 Gigabit Ethernet
- Networks with RS-485 interface
- Analog and digital interfaces for telecommunications, including DSL

More information starting on page 70



Compact protection for telecommunications applications

With an overall width of just 6 mm, TERMITRAB complete provides narrow and reliable protection for telecommunications interfaces in the form of the TTC-6-1X2-TELE solution.

- Product information on page 75
- TERMITRAB complete product family information on page 44



Intelligent protection for data interfaces

The intelligent PLUGTRAB PT-IQ surge protection solution reliably protects your data cables against surge voltages. The protective circuit has been tailored specially to HF applications.

- Product information on page 76
- PLUGTRAB IQ product family information on page 54

Surge protection for information technology

Ideal protection for every interface

With the DATATRAB family, you can easily protect your networks and telecommunications systems against damage due to overvoltage. Whether connected directly to the computer as an adapter or with just a click onto the DIN rail, DATATRAB is installed in no time.



Your advantages

- ✓ Conformance with all standards – both for surge protection and for high-speed networks
- ✓ Protection for all common applications and signals with the complete product portfolio
- ✓ Versatile use with application-specific designs and connection technologies

DATATRAB – universal protection for information technology



Versatile

The DATATRAB product family features protective devices ideal for the RJ11/12, RJ45, and D-SUB interfaces.



Fast

Used in IT systems with up to 10 Gbps (CAT6 / CLASS Ea) and in telecommunications networks with 50 Mbps (VDSL).

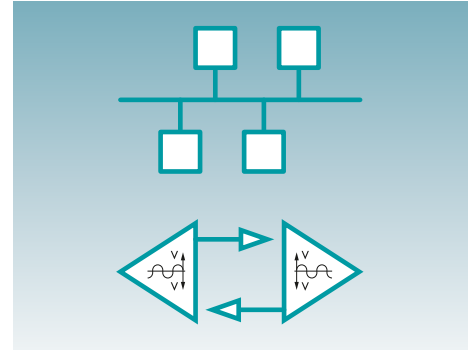

Universal

For all common applications: Ethernet, Token Ring, ISDN, DS1, DSL, analog telecommunications, RS-485, V.24, V.11, etc.

Universal protection for data interfaces

DATATRAB DT reliably protects high-speed networks against damage caused by surge voltages. In just one device, the DT-LAN-CAT.6+ can manage various data protocols at high transmission rates such as Ethernet, “Power-over-Ethernet” (PoE), ISDN, Token Ring, and DS1.

The housing has a ground connection snap-on foot into which the ground connection cover with equipotential bonding line is inserted. DATATRAB can therefore be used as an adapter or as a DIN rail module, after removing the ground connection cover.

The protective devices must guarantee short response times to quickly limit surge voltages to safe values, without impairing signal quality. In addition, the protective devices support system-specific connections, such as RJ45 or D-SUB connectors, and all types of network topologies.

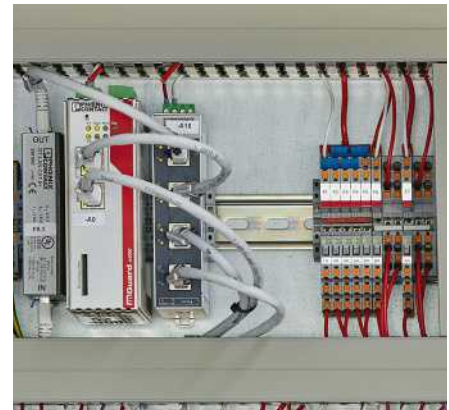

DATATRAB in use

Ultra-slim or also pluggable

The TERMITRAB complete (from p. 44) and PLUGTRAB IQ (from p. 56) product families also include products for protecting your analog and digital telecommunications interfaces.

With an overall width of just 6.2 mm, the TTC-6-1X2-TELE is ideal for VDSL and G.fast applications with up to 300 Mbps with VDSL and 1.5 Gbps with G.fast. Both product families also include products with protective circuits specially tailored to HF applications.

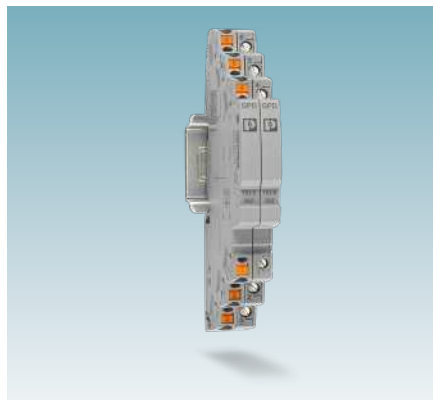





TERMITRAB complete



PLUGTRAB-IQ

Universal protection for information technology



ETHERNET/PROFINET			
			
Connection technology	RJ45	RJ45	RJ45
Description	For LAN interfaces (Class D/Cat5) incl. PoE+ and ISDN S0 protection		For LAN interfaces (Class EA/Cat6) incl. PoE+ and ISDN S0 protection
Type in accordance with IEC	B2, C1	B2, C2, D1, C1	B2, C1, C2, C3, D1
Maximum continuous operating voltage U_c	± 48 V DC	± 5 V DC	
Rated current	≤ 1.5 A (25°C)		≤ 1.5 A (25°C)
Total discharge surge current I_{total}	-	8 kA	10 kA
Type	D-LAN-CAT.5-FP	D-LAN-CAT.5-HC	DT-LAN-CAT.6+
Item number	2800723	2800763	2881007





RS-485/PROFIBUS		
		
Connection technology	D-SUB-9	Screw connection and D-SUB-9
Description	For RS-485 interfaces with D-SUB 9 connection	PROFIBUS fine protection with D-SUB 9
Type in accordance with IEC	B2, C1, C2, C3, D1	C1, C3, B2
Maximum continuous operating voltage U_c	12 V DC	5.2 V DC
Rated current	≤ 380 mA (25°C)	250 mA (25°C)
Total discharge surge current I_{total}	10 kA	350 A
Resistance per path	3.3 Ω 10%	-
Type	DT-UFB-485/BS	D-UFB-PB
Item number	2920612	2880642

Universal protection for information technology







1
2
3
4
5





Surge protection for information technology

TELEKOM		
		
Connection technology	RJ45 / COMBICON	RJ45 / COMBICON
Description	Intermediate plug for two VDSL interfaces (ports)	Intermediate plug for two SHDSL interfaces (ports)
Type in accordance with IEC	B2, C1, C2, C3, D1	
Maximum continuous operating voltage U_c	185 V DC / 130 V AC	
Rated current	≤ 380 mA (25°C)	
Total discharge surge current I_{total}	10 kA	
Resistance per path	3.3 Ω 10%	3.3 Ω 20%
Type	DT-TELE-RJ45	DT-TELE-SHDSL
Item number	2882925	2801593



RS-485/PROFIBUS, directly grounded				
				
Pluggable	No	No	Yes	Yes
Knife disconnection	No	Yes	No	Yes
Number of signal wires	3	3	3	3
Rated current	600 mA (40°C)		600 mA (56°C)	
Maximum continuous operating voltage U_c	15 V DC / 10 V AC			
IEC test classification	C1, C2, C3, D1			
Pulse discharge current I_{imp} (10/350) μ s	0.5 kA			
Total discharge current I_{total} (8/20) μ s	10 kA			
Resistance per path	1.65 Ω \pm 20%			
Push-in connection	TTC-6-3-HF-12DC-PT 1065316	TTC-6-3-HF-M-12DC-PT-I 2906732	TTC-6P-3-HF-12DC-PT-I 1065313	TTC-6P-3-HF-M-12DC-PT-I 2906756
Screw connection		TTC-6-3-HF-M-12DC-UT-I 2906721		TTC-6P-3-HF-M-12DC-UT-I 2906744





Compact protection for information technology

RS-485/PROFIBUS, indirectly grounded					
					
Pluggable	No	No	Yes	Yes	No
Knife disconnection	No	Yes	No	Yes	No
Number of signal wires	3	3	3	3	3
Rated current	600 mA (40°C)		600 mA (56°C)		600 mA (40°C)
Maximum continuous operating voltage U_c	15 V DC	15 V DC / 10 V AC			43 V DC / 30 V AC
IEC test classification	C1, C2, C3, D1				
Pulse discharge current I_{imp} (10/350) μ s	0.5 kA				-
Total discharge current I_{total} (8/20) μ s	10 kA				
Resistance per path	1.65 Ω \pm 20%				
Push-in connection	TTC-6-3-HF-F-12DC-PT 1109712	TTC-6-3-HF-F-M-12DC-PT-I 2906778	TTC-6P-3-HF-F-12DC-PT-I 1065314	TTC-6P-3-HF-F-M-12DC-PT-I 2906796	TTC-6-3-HF-F-24AC-PT-I 1088786
Screw connection		TTC-6-3-HF-F-M-12DC-UT-I 2906769		TTC-6P-3-HF-F-M-12DC-UT-I 2906786	

For potentially explosive applications, PROFIBUS PA fieldbus systems				
				
Pluggable	No	Yes	No	Yes
Knife disconnection	Yes	Yes	Yes	Yes
Number of signal wires	3	3	3	3
Rated current	600 mA (40°C)			
Maximum continuous operating voltage U_c	15 V DC		30 V DC	
IEC test classification	C1, C2, C3, D1			
Pulse discharge current I_{imp} (10/350) μ s	0.5 kA			
Total discharge current I_{total} (8/20) μ s	10 kA			
Resistance per path	1.65 Ω \pm 20%			
Screw connection	TTC-6-3-HF-F-M-EX-12DC-UT-I 2906822	TTC-6P-3-HF-F-M-EX-12DC-UT-I 2906826	TTC-6-3-HF-F-M-EX-24DC-UT-I 2906823	TTC-6P-3-HF-F-M-EX-24DC-UT-I 2906828

Compact protection for information technology

TELEKOM			
COMPLETE line			
Connection technology	Push-in connection	new	Screw connection
Description	Surge protection for analog and digital telecommunications interfaces (VDSL up to 300 Mbps, G.fast up to 1.5 Gbps). Integrated overload protection (power-cross).		
Type in accordance with IEC	B2, C1, C2, C3, D1		
Maximum continuous operating voltage U_c	60 V DC		
Rated current	200 mA		
Pulse discharge current I_{imp} (10/350) μ s	0.5 kA		
Total discharge current I_{total} (8/20) μ s	10 kA		
Resistance per path	6 Ω		
Type	TTC-6-1X2-TELE-PT		TTC-6-1X2-TELE-UT
Item number	1077106		1077107

Remote signaling sets and modules				
COMPLETE line				
				
Connection technology	Push-in connection	Screw connection	Push-in connection	new
Brief description	Remote signaling set		Remote signaling module – receiver	Remote signaling module – transmitter
Product characteristic	Transmission and receiver module for remote signaling of TTC-6...-I products			
Type	TTC-6-FMRS-PT	TTC-6-FMRS-UT	TTC-6-FMRX-PT	TTC-6-FMTX-PT
Item number	2907811	2907810	1193571	1193565

Intelligent protection for information technology

RS-485/PROFIBUS, directly grounded

			
Number of signal wires	3	3	5
Rated current	600 mA (40°C)		
Maximum continuous operating voltage U_c	6 V DC / 4 V AC	15 V DC / 10 V AC	
IEC test classification	C1, C2, C3, D1		
Pulse discharge current I_{imp} (10/350) μ s	2.5 kA		
Total discharge current I_{total} (8/20) μ s	20 kA		
Resistance per path	1.2 Ω \pm 5%		
Push-in connection	PT-IQ-3-PB-PT 2801286	PT-IQ-3-HF-12DC-PT 2801288	PT-IQ-5-HF-12DC-PT 2801293
Screw connection	PT-IQ-3-PB-UT 2800785	PT-IQ-3-HF-12DC-UT 2800786	PT-IQ-5-HF-12DC-UT 2800799

RS-485/PROFIBUS, indirectly grounded

			
Number of signal wires	3	3	5
Rated current	600 mA (40°C)		
Maximum continuous operating voltage U_c	6 V DC / 4 V AC	15 V DC / 10 V AC	
IEC test classification	C1, C2, C3, D1		
Pulse discharge current I_{imp} (10/350) μ s	2.5 kA		
Total discharge current I_{total} (8/20) μ s	20 kA		
Resistance per path	1.2 Ω \pm 5%		
Push-in connection	PT-IQ-3-PB+F-PT 2801287	PT-IQ-3-HF+F-12DC-PT 2801289	PT-IQ-5-HF+F-12DC-PT 2801295
Screw connection	PT-IQ-3-PB+F-UT 2800994	PT-IQ-3-HF+F-12DC-UT 2800995	PT-IQ-5-HF+F-12DC-UT 2800801

Intelligent protection for information technology

TELEKOM		
		
Connection technology	Push-in connection	Screw connection
Description	Double wire (loop), floating, connection 9/10 directly grounded, e.g., for DSL applications	
Type in accordance with IEC	B2, C1, C2, C3, D1	
Maximum continuous operating voltage U_c	180 V DC	
Rated current	150 mA (25°C)	
Pulse discharge current I_{imp}	2.5 kA	
Total discharge surge current I_{total}	20 kA	
Resistance per path	1.2 Ω \pm 5%	
Type	PT-IQ-1X2-TELE-PT	PT-IQ-1X2-TELE-UT
Item number	2801290	2800769

Supply and remote signaling modules		
		
Connection technology	Screw connection	Push-in connection
Type	PT-IQ-PTB-UT	PT-IQ-PTB-PT
Item number	2800768	2801296

Surge protection for transmitter and receiver systems

Transmitter and receiver systems are particularly sensitive to overvoltage. Antenna cables which extend beyond the building and which are therefore very long, and the antennas themselves, are exposed directly to atmospheric discharges.

Overvoltages can reach the sensitive interfaces of the system via the conductor paths and impair or even interrupt transmission.

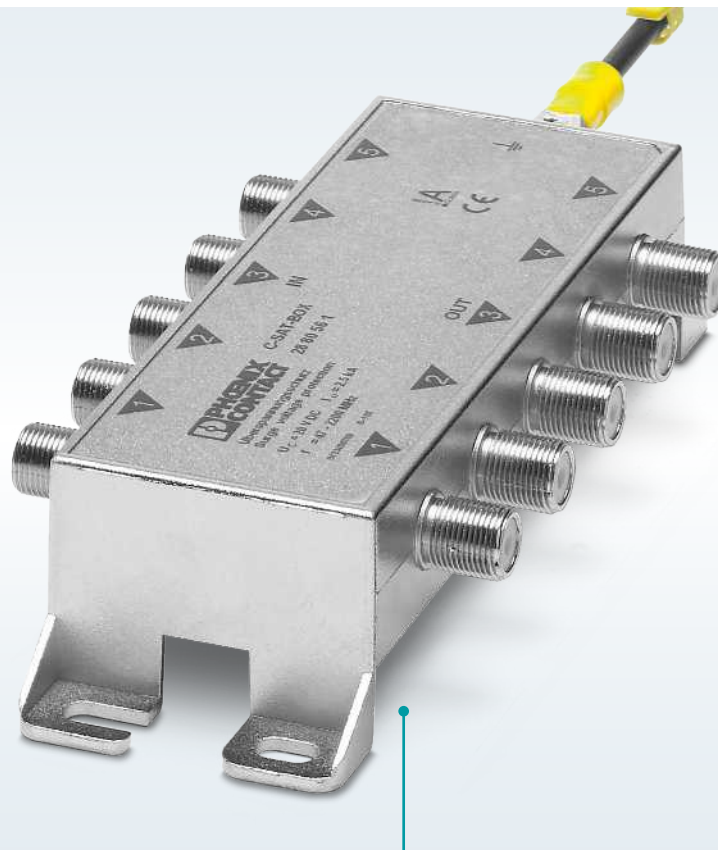

Protection for antenna inputs in satellite receiver technology

Good shielding properties are vital for “clean” transmission. The robust metal housings provide ideal shielding properties and are also suitable for use in harsh industrial environments.

More information on page 80



Protection for antennas with N, BNC, and SMA connection

The protective devices conform to standards in all performance classes. This applies for coarse protection in accordance with Category D1 and for fine protection in accordance with Category C2 and C1.

More information on page 81

Surge protection for transmitter and receiver systems



Protection for home applications

Satellite systems for TV reception are installed in very many residential homes, whether for single families or several families. The C-SAT-Box can be connected directly to the multi-switch to prevent the antenna splitter on satellite equipment from failing due to overvoltage.



Your advantages

- ✓ No signal interference thanks to optimum transmission properties
- ✓ Protection of digital and analog signals with a universal protective circuit
- ✓ Easy installation with surface mounting

TV		
		
Connection method	F connector	F connector
Frequency range	47 MHz ... 2.5 GHz	4.7 MHz ... 2.5 GHz
Type in accordance with IEC	B2, C1, C2, C3, D1	C1, C2, C3, D1
Maximum continuous operating voltage U_c	20 V DC	24 V DC
Rated current	400 mA	1.5 A (25°C)
Pulse discharge current I_{imp} (10/350) μs	0.5 kA	
Total discharge current I_{total} (8/20) μs	10 kA	-
Resistance per path	3.3 Ω $\pm 20\%$	-
Connection type: Female to female	C-SAT-BOX 2880561	C-TV-SAT 2856993

Surge protection for transmitter and receiver systems

Protection for industrial applications





Cables with a coaxial structure and therefore favorable EMC properties are also primarily used in industrial antenna systems. However, the danger of surge voltage coupling in antenna cables and potential transfer through to the sensitive interfaces of transmitter and receiver systems is not eliminated. The COAXTRAB product family enables you to significantly increase the availability and operability of the devices in question.



Your advantages

- ✓ Easy installation with system-compliant connection
- ✓ Use under extreme ambient conditions thanks to robust design
- ✓ Exceptional protective properties with Lambda/4 technology

GSM/LTE/WiMAX

				
Connection method	N connector 50 Ω	N connector 50 Ω	N connector 50 Ω	N connector 50 Ω
Frequency range	0.8 GHz ... 2.25 GHz	2.4 GHz ... 7.6 GHz	0 Hz ... 3 GHz	0 Hz ... 6 GHz
Type in accordance with IEC	C2, C3, D1			
Maximum continuous operating voltage U_c	-		280 V DC	70 V DC / 50 V AC
Rated current	5 A (25°C)			10 A
Pulse discharge current I_{imp} (10/350) μs	20 kA		2.5 kA	1 kA
Total discharge current I_{total} (8/20) μs	60 kA		20 kA	5 kA
Connection type: Female to female	CN-LAMBDA/4-2.25-BB 2801057	CN-LAMBDA/4-5.9-BB 2838490	CN-UB-280DC-3-BB 2801050	CN-UB-70DC-6-BB 2803166
Connection type: Male to female	CN-LAMBDA/4-2.25-SB 2801056	CN-LAMBDA/4-5.9-SB 2800023	CN-UB-280DC-3-SB 2801051	CN-UB-70DC-6-SB 2803153

Test and monitoring devices

Whether cloud-based in real time or manually, the test and monitoring devices are a perfect way to increase system availability. Overvoltage can overload electrical installations and the protective devices intended to protect them. Determine the state of your system and your surge protection at an early stage, before failures occur.



Intelligent assistance system for surge protection

ImpulseCheck monitors the surge protective devices in your system. In addition, it enables you to carry out a simple and comprehensive analysis of the system EMC characteristics.

More information on pages 84/85



Lightning monitoring system

The measuring system detects and analyzes all important parameters associated with lightning surge currents. Evaluation and remote signaling is in real time. The system operating parameters and measured data provide a basis for making decisions regarding inspection and maintenance activities.

More information on pages 88/89



Test system for surge protective devices

With the CHECKMASTER 2, you can test lightning protection systems in accordance with IEC 62305-3.

More information on pages 86/87

Test and monitoring devices

Keeping the pulse of your system – monitoring for your surge protection

ImpulseCheck is the world's first intelligent assistance system for surge protection in the field of mains protection. The module enables you to measure the state of health (SoH) of every single protective device using cloud connection, and provides you with new digital services.

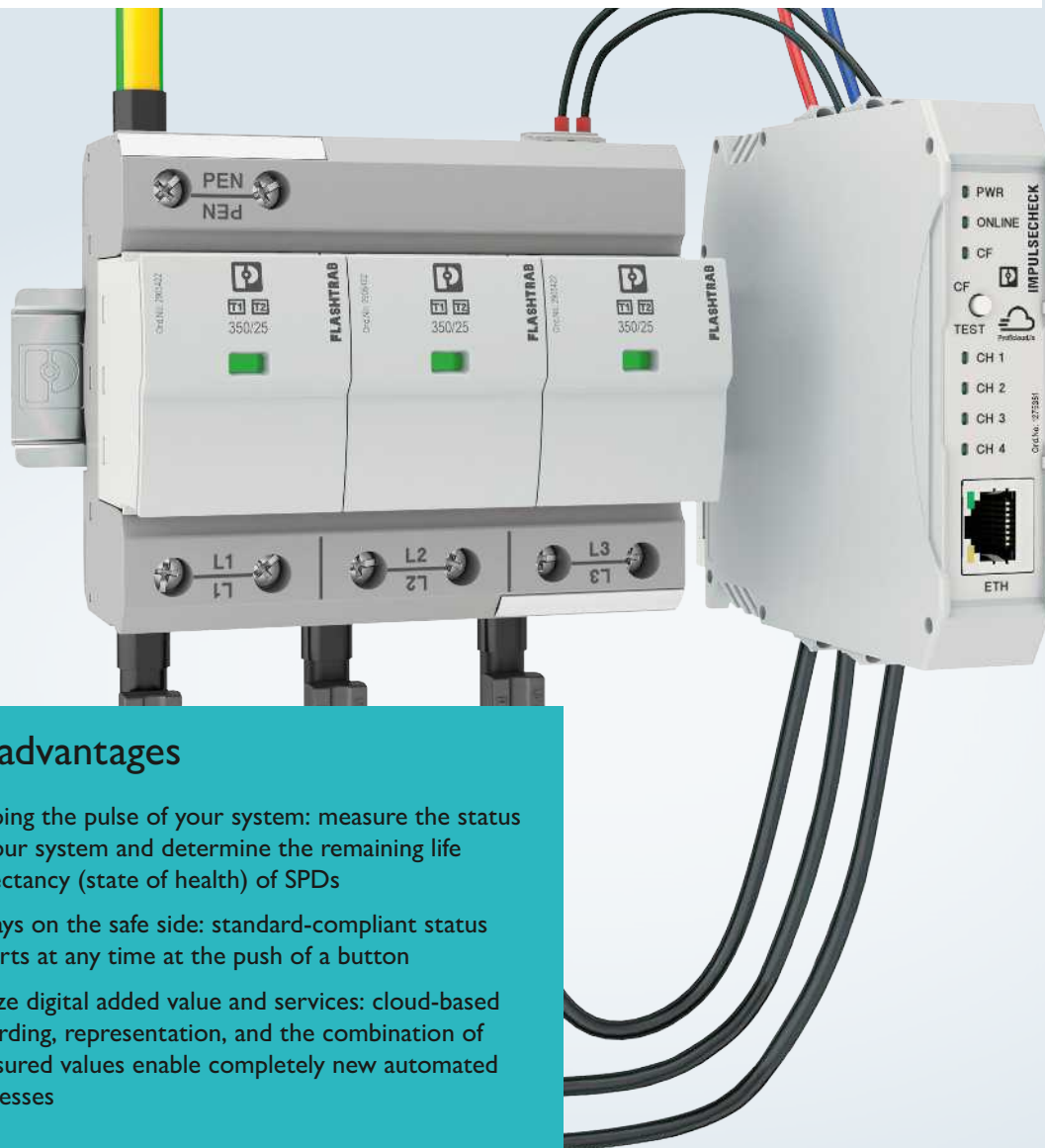

Your advantages

- ✓ Keeping the pulse of your system: measure the status of your system and determine the remaining life expectancy (state of health) of SPDs
- ✓ Always on the safe side: standard-compliant status reports at any time at the push of a button
- ✓ Utilize digital added value and services: cloud-based recording, representation, and the combination of measured values enable completely new automated processes

Impulse Check – intelligent assistance system



Keeping the pulse of your system

Benefit from predictive maintenance:
Thanks to real-time measurement of surge currents and transient overvoltages, you can continuously monitor the condition of the system and the surge protection. This makes the remaining service life expectancy (state of health - SoH) of the protective devices transparent, so that maintenance activities can be predicted more easily.

Status reports at the push of a button

Depending on the system type, the IEC 62305-3 standard requires that surge protective devices are tested at specific intervals. With real-time monitoring, you know the SPD's state and can generate status reports at any time at the push of a button – even between the predetermined test intervals. Thus you are perfectly informed, whenever you want.

ImpulseAnalytics

ImpulseCheck and ImpulseAnalytics in PROFICLOUD come together to create the first assistance system for surge protection. Through interaction with a powerful surge protection concept, this provides ideal protection and high system availability. While the hardware records the measured data with a very high temporal resolution, the data is evaluated in the application.

IMPULSECHECK

			
Description	Evaluation unit	Sensor with 3 m cable	Sensor with 1.5 m cable
Type	IPCH-4X-PCL-TCP-24DC-UT	IPCH-SC-3.0	IPCH-SC-1.5
Item number	1045379	1069191	1045380

Test and monitoring devices

The test system for surge protective devices

Lightning protection systems must be tested in accordance with the requirements of IEC 62305-3 and official regulations. A visual inspection is not enough to identify surge protective devices that have pre-existing damage. Only an electrical test, such as the one performed by CHECKMASTER 2, produces meaningful results. It automatically tests all of the relevant components of surge protective devices.



CHECKMASTER 2 test device

For testing the correct function of surge protective devices from Phoenix Contact. Test adapters are not supplied with the CHECKMASTER 2. The necessary test adapters must be ordered separately.

- Item number [2905256](#)

Your advantages

- ✓ Fully automatic electrical testing of pluggable surge protective devices due to integrated PLC with high-voltage power supply unit
- ✓ Easy replacement of test adapters with tool-free interlocking
- ✓ Electrical test with voltages up to 2,000 V DC

CHECKMASTER 2 test system



Testing

The product can be entered quickly and without errors using the bar codes provided on the surge protective devices. System-specific abbreviations or user-defined codes can be entered via the operator terminal and also read in via individually created bar code labels. Alternatively, the test object item number can be entered via the touch panel.

Saving and documentation

All relevant components of the protective plug are electrically tested in an automatic test process. The results of these tests are shown on a color display. The CHECKMASTER 2 saves all test results in the internal non-volatile memory. The test reports can be transferred via USB flash drive for convenient further processing in Office programs.

Suitable for a wide range of applications

The CHECKMASTER 2 has a modular design. Corresponding test adapters are available for the various surge protective devices. You can use CHECKMASTER 2 not only to test surge protective devices for the power supply, but also to test products for protecting the measurement and control technology.

CHECKMASTER 2 test adapter for the product range(s):

Product series	PLT-SEC...UT/PT 17.5 mm	CLT-10P/20P...I-P	VAL-MS	CTM	FLT-CP, FLT-SEC, VAL-CP, VAL-SEC
Type	CM 2-PA-PLT-UT/PT	CM 2-PA-CLT	CM 2-PA-VAL-MS	CM 2-PA-CTM	CM 2-PA-FLT/VAL-CP/ SEC
Item number	1027866	1183360	2905265	2905282	2905283
Product series	PT, PLT-SEC 17.5 mm	PT, PLT-SEC 35 mm	FLT-SEC-H	UFBK, UAK	TTC-6P...UT/PT-I
Type	CM 2-PA-PT/PLT	CM 2-PA-PT4/PLT3S	CM 2-PA-SEC-HYBRID	CM 2-PA-PT/A	CM 2-PA-TTC
Item number	2905284	2907019	2907889	2907891	2908707

Test and monitoring devices

Optimum maintenance planning with the LM-S lightning monitoring system

LM-S is the live monitoring system for the continuous detection and evaluation of lightning strikes. It detects and analyzes all important parameters associated with lightning surge currents. The actual loads on the system can be derived from this. Using this information, you can decide on the necessity for inspection or maintenance actions.



Your advantages

- ✓ Easy detection and evaluation of lightning current loads with the intelligent measuring system
- ✓ Maintenance can be planned better with continuous remote monitoring
- ✓ Easy data output and configuration via the integrated web server

LM-S lightning monitoring system

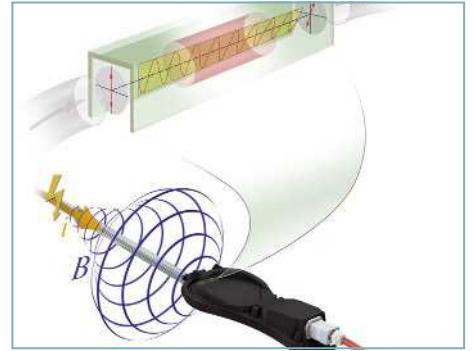

Acquisition and evaluation

The sensors are mounted on the lightning current down conductors. They record the magnetic field around the conductor due to the lightning surge current. The measured result is transmitted via fiber optics to the O/E module of the evaluation unit, where the optical signal is converted into an electrical signal. The evaluation unit uses the values obtained to determine the lightning characteristic with the typical parameters such as the maximum lightning current intensity, rate of lightning current rise, charge, and energy.

Remote monitoring in real time

The evaluation unit can be easily integrated into standard network systems via the RJ45 Ethernet interface. The data acquired can be accessed and the system can be configured via web interface, Modbus/TCP, or OPC UA. The web interface is opened via the Internet browser on a PC connected to the system using IP addressing.

Faraday effect

The internal measuring principle of the LM-S is based on the Faraday effect. Polarized light in a specific medium is rotated through a magnetic field over a defined length and measured. The higher the current strength (i) generated by a lightning strike, the greater the magnetic flux density (B) and, therefore, the rotation of the polarized light. The lightning monitoring system detects this change in the light signal and derives the measured value results accordingly.

LM-S components

				
Description	Evaluation unit	Sensor	Connecting cables	O/E module
Type	LM-S-A/C-3S-ETH	LM-S-LS-H	Suitable connection cables on request.	LM-S-C-3LS
Item number	2800618	2800616		2800617

COMPLETE line – the comprehensive solution for the control cabinet

COMPLETE line system encompasses technologically leading and coordinated hardware and software products, consulting services, and system solutions that help you optimize your processes in control cabinet manufacturing. Engineering, purchasing, installation, and operation become significantly easier for you.

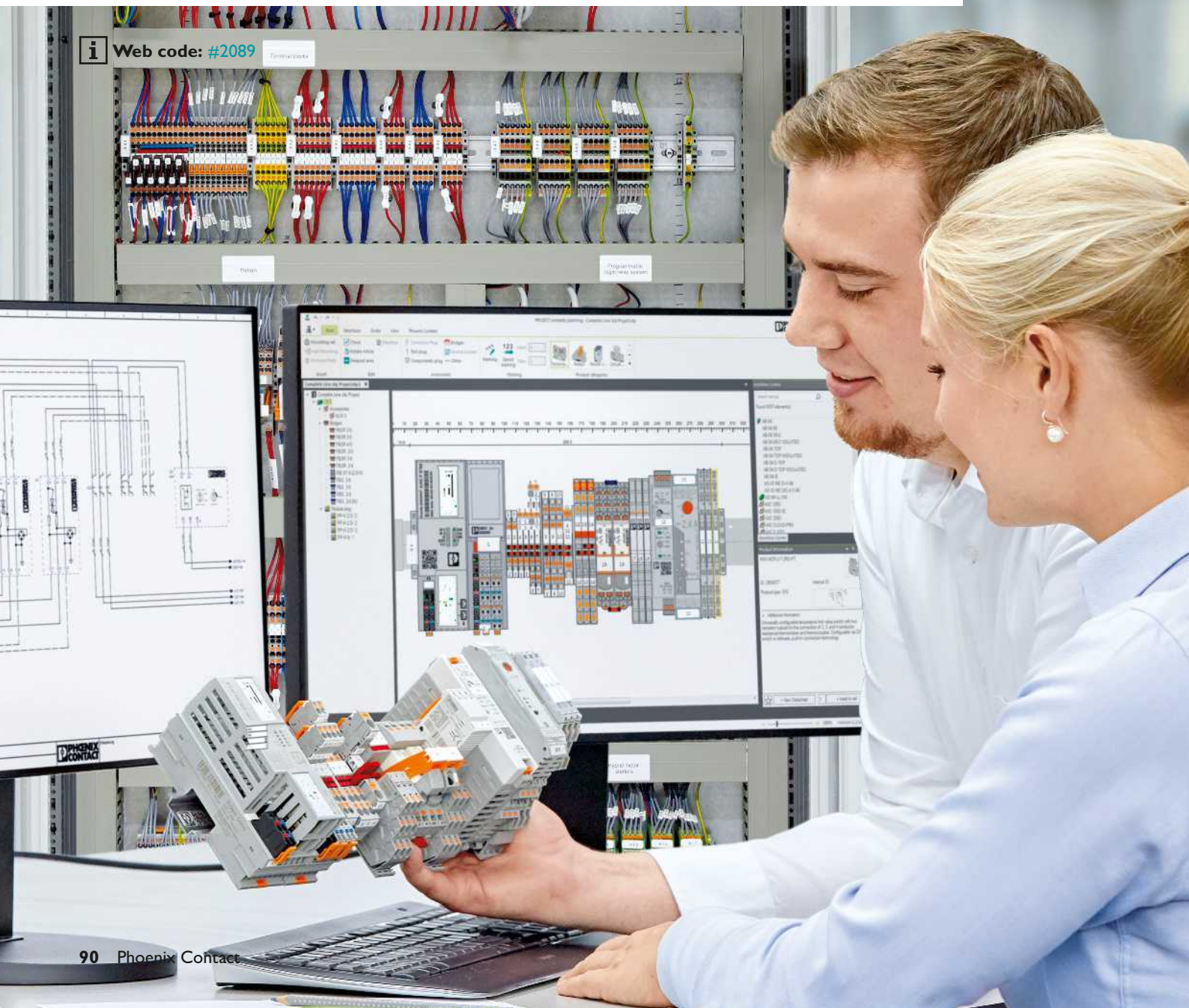

Your advantages in detail:



Comprehensive product portfolio

With COMPLETE line, we offer a complete product portfolio of technologically leading products. This includes:

- Controllers and I/O modules
- Power supplies and device circuit breakers
- Terminal blocks and distribution blocks
- Relay modules and motor starters
- Signal conditioners
- Safety technology
- Surge protection
- Heavy-duty connectors



Intuitive handling

With the simple, intuitive handling of the coordinated hardware components, you will save time during installation, commissioning, and maintenance. With Push-in connection technology, you can wire applications quickly and without using tools. The broad, technologically leading product portfolio will always provide you with the right product for standard or special applications.



Save time throughout the entire engineering process

PROJECT complete planning and marking software supports the entire process of control cabinet manufacturing. The program features an intuitive user interface that allows the individual planning, automatic checking, and direct ordering of terminal strips.



Reduced logistics costs

Reduced variety of parts with standardized marking, bridging, and testing accessories. The COMPLETE line system coordinates products, design, and accessories so that you benefit from maximum reusability and thus reduce your logistics costs.



Optimized processes in control cabinet manufacturing

COMPLETE line supports you, from engineering through to manufacturing, in designing your control cabinet production as efficient as possible. This is how your customized concept for optimizing your processes in control cabinet manufacturing is created. Our terminal strip production helps you to flexibly manage order peaks or to supply your control cabinet production with fully assembled DIN rails just in time.



The new standard for the control cabinet

Discover the extensive COMPLETE line product portfolio and find out more about COMPLETE line and your comprehensive solutions for the control cabinet.

Visit our website:
phoenixcontact.com/completeline

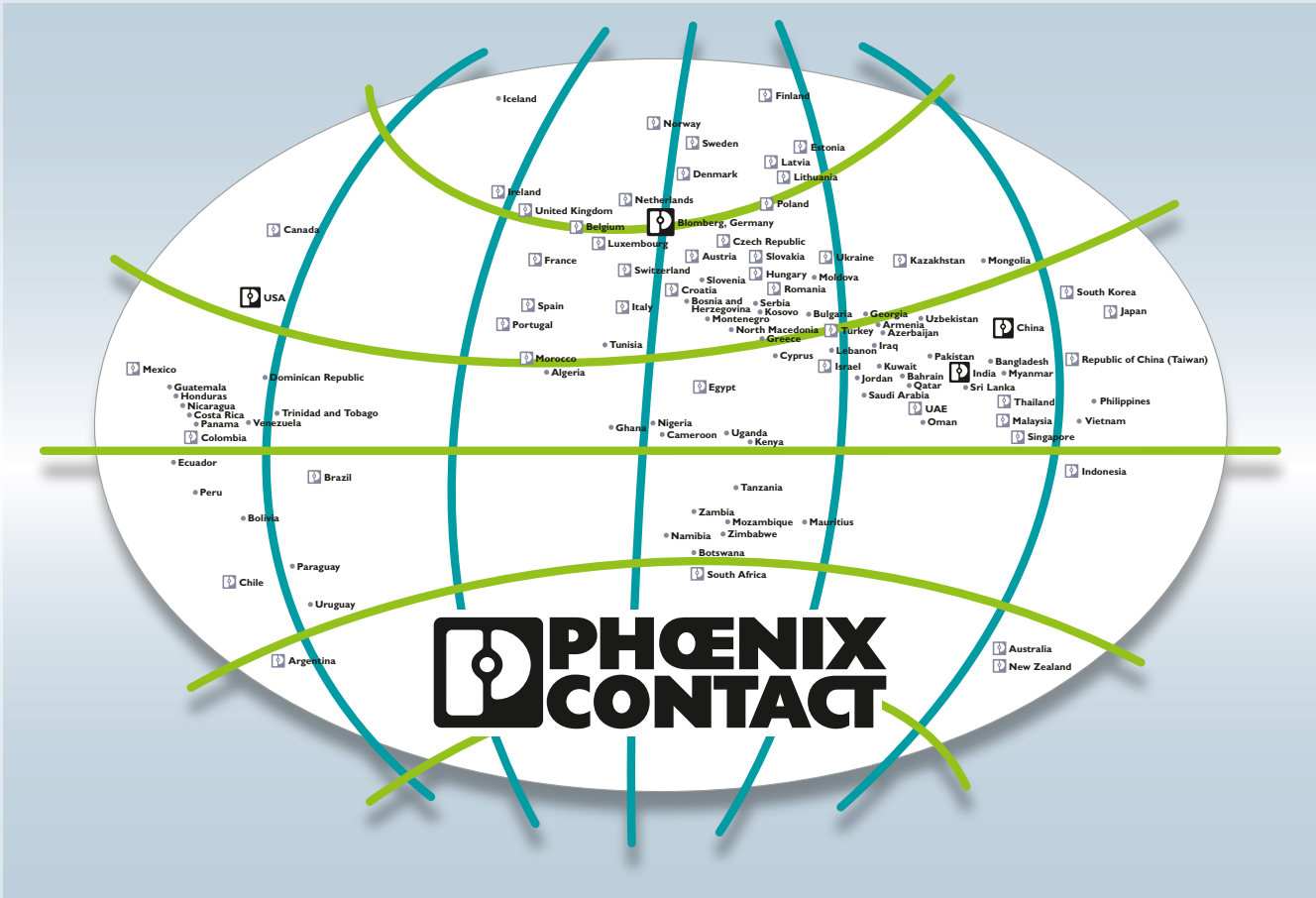

Open communication with customers and partners worldwide

Phoenix Contact is a global market leader based in Germany. We are known for producing future-oriented products and solutions for the electrification, networking, and automation of all sectors of the economy and infrastructure. With a global network reaching across more than 100 countries with over 22,000 employees, we maintain close relationships with our customers, something we believe is essential for our common success.

Our wide range of innovative products makes it easy for our customers to implement the latest technology in a variety of applications and industries. This especially applies to the target markets of energy, infrastructure, industry, and mobility.

You can find your local partner at
phoenixcontact.com