

2023



Signal conditioning and explosion protection

Signal conditioners, measuring transducers, I/O signal marshalling, process displays, and field devices



Interference-free and safe signal conditioning, transmission, and visualization

Our product portfolio for signal conditioning ensures interference-free signal transmission from the sensor level to the control level. In addition, intrinsically safe, SIL-certified signal conditioners and measuring transducers provide explosion protection and ensure the safety of people, the environment, and the system. You can also control and visualize your process data directly in the field using our process displays.

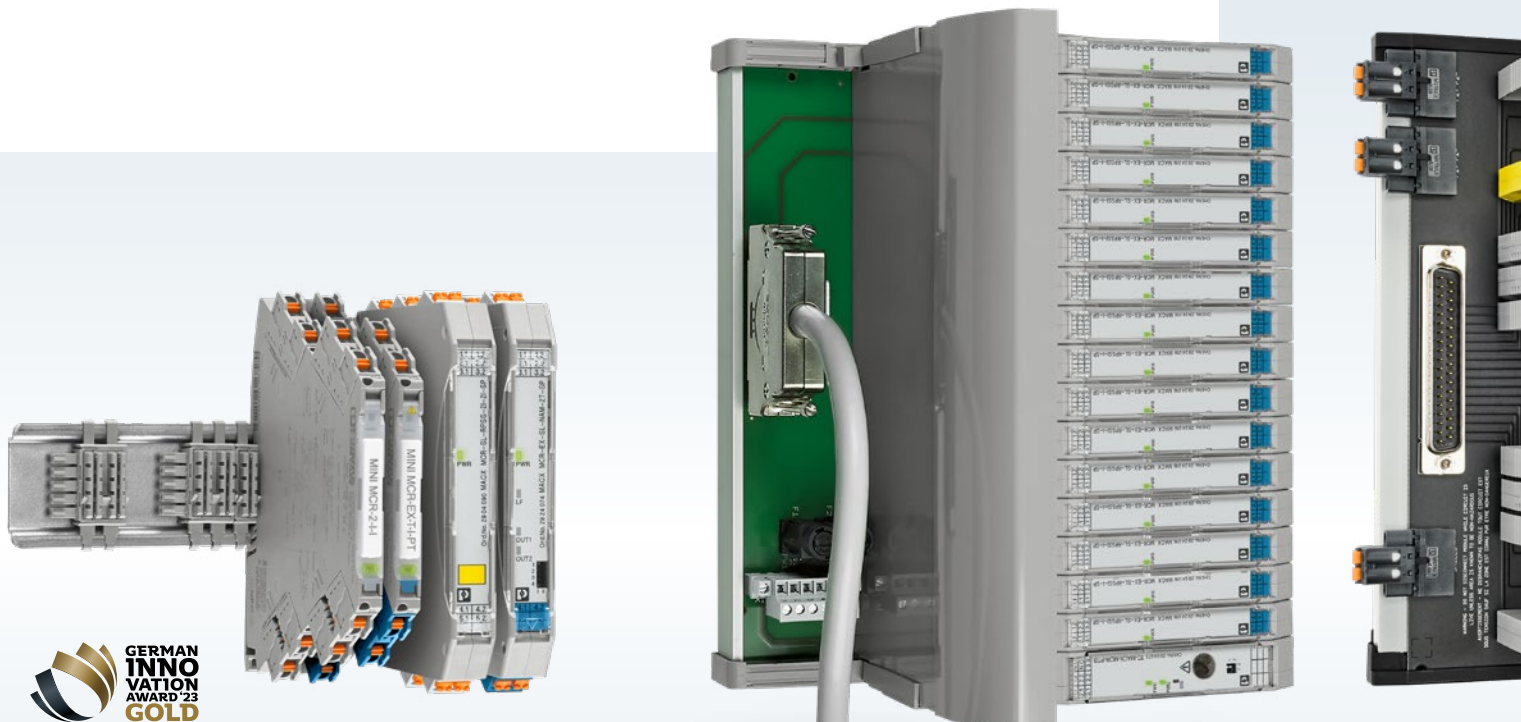

1 Signal conditioners and measuring transducers

- Highly compact MINI Analog Pro signal conditioners and measuring transducers for standard applications and explosion protection
- MACX analog signal conditioners and measuring transducers for standard applications and explosion protection
- System components and accessories

More information starting on page 6

2 I/O signal marshalling

- Signal marshalling for standard I/O systems with Termination Carriers
- Signal marshalling for Universal I/O systems with VIP I/O marshalling

More information starting on page 62

GOLD at the German Innovation Award for the highly compact MINI Analog Pro Ex i signal conditioners with SIL 3.

Find out which of the MINI Analog Pro features convinced the jury to award this innovation prize here.

Simply type the web code into the search field on our website.



i Web code: #3364



3

Process displays and field devices

- Field Analog multifunctional process displays, output loop-powered process displays, and 7-segment LED displays
- Field Analog output loop-powered temperature transducers and head-mounted temperature transducers
- HART® communication

More information starting on page 84

Contents

Signal conditioning, signal marshalling, and explosion protection	4
Signal conditioners and measuring transducers	6
Highly compact MINI Analog Pro signal conditioners and measuring transducers	8
MACX Analog signal conditioners and measuring transducers	30
System components and accessories	56
I/O signal marshalling	62
Signal marshalling for standard I/O systems	66
Signal marshalling for Universal I/O systems	72
Process displays and field devices	84
Process displays	86
Loop-powered temperature transducers	90
HART® communication	96
Our services for signal conditioning and explosion protection	100
Further products for signal conditioning and explosion protection	102
COMPLETE line	104
Worldwide service and support	106

Signal conditioning, signal marshalling, and explosion protection

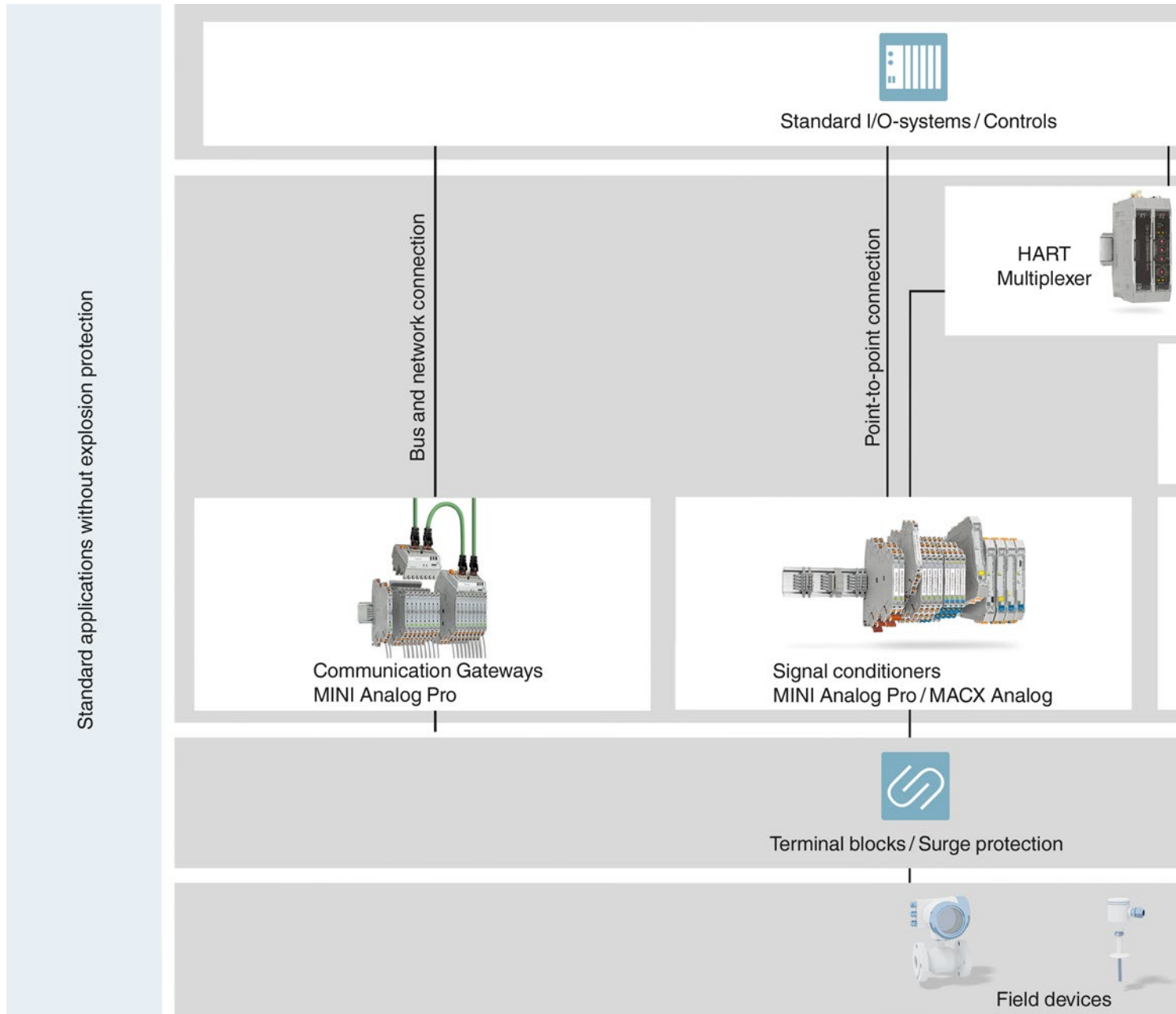

Signal conditioners and measuring transducers for standard applications

As the interface between the field and the controller, signal conditioners and measuring transducers ensure correct and safe signals.

Functions of signal conditioners and measuring transducers

In standard signal conditioning applications, signal conditioners and measuring transducers perform the following functions:

- Filtering out unwanted frequencies that negatively influence the signal chain
- Converting signals
- Electrical isolation, preventing signal-distorting ground loops

- Amplifying signals to provide enough power at high loads
- Duplicating signals with electrical isolation, for example, to separate safety circuits and process circuits

Connection to the I/O or control level

The connection to controllers or I/O systems can be established in various ways:

- Via point-to-point individual wiring
- Via I/O signal marshalling systems for connection via point-to-point system cabling

- Via communication gateways for digitalizing and integrating your process signals into bus and network structures

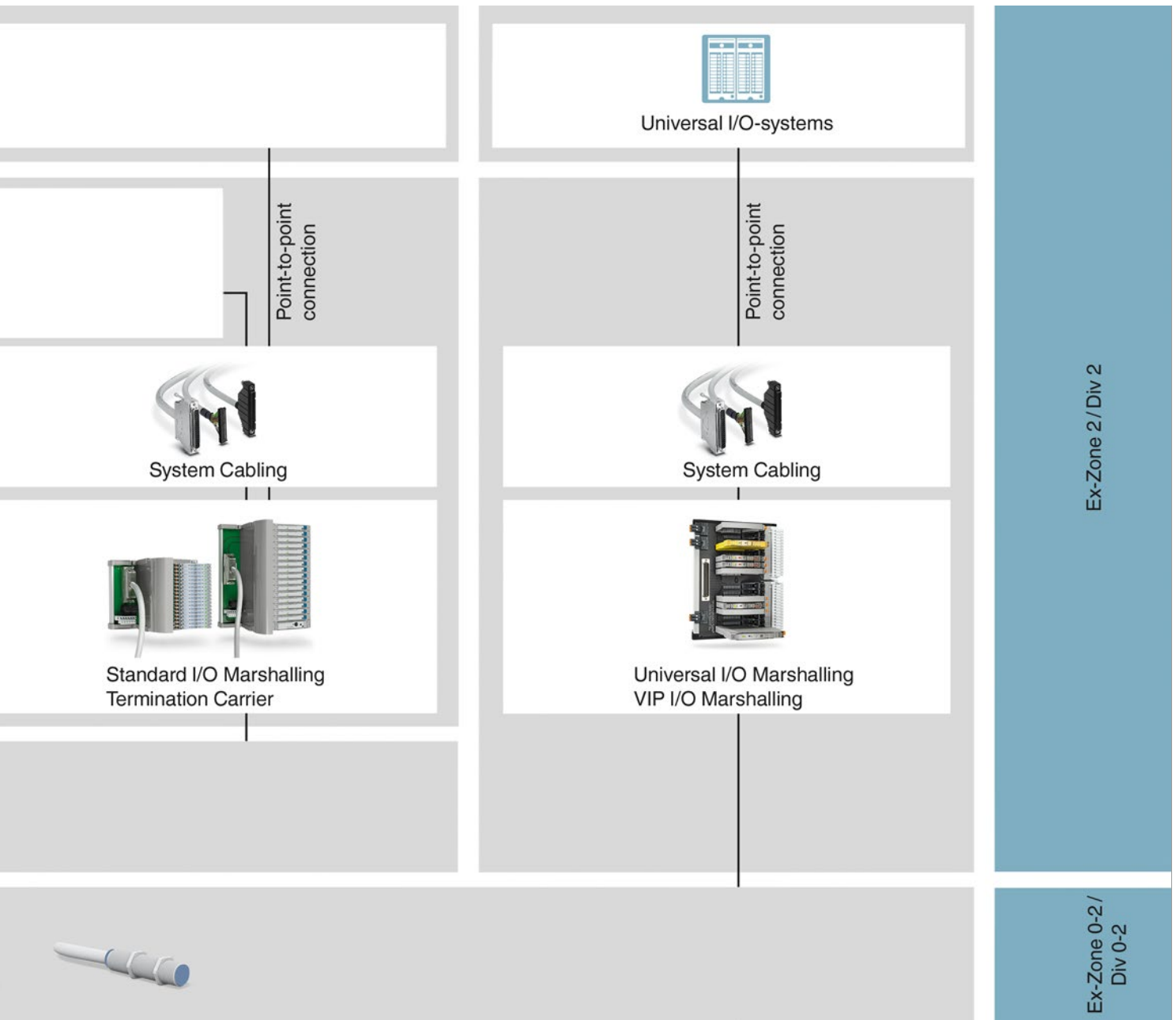

Signal conditioners and measuring transducers for explosion protection

In addition to their standard functions, signal conditioners and measuring transducers for explosion protection and functional safety ensure the safety of people, systems, and the environment in accordance with the relevant standards:

Explosion protection:

The consistent Ex i type of protection ensures explosion protection by limiting the electrical energy to the field in areas up to zone 0. The additional type of protection for increased safety, Ex ec, enables the devices to be mounted in areas up to zone 2 and

also ensures explosion protection there.

In summary, the signal conditioners and measuring transducers from Phoenix Contact provide you with electrical explosion protection for all substance groups and areas.

Functional safety:

There are systems which, in the event of a fault, pose a risk to the environment and people. It is also important here to avert material system damage. Functional safety is aimed at minimizing these hazards to an acceptable residual risk. Our signal conditioners and measuring transducers

fulfill this task through consistent product development and evaluation in accordance with SIL (IEC 61508) and PL (DIN EN ISO 13849).

Connection to the I/O or control level

The connection to controllers or I/O systems is established in the same way as in the standard applications.

Signal conditioners and measuring transducers

With our signal conditioners and measuring transducers, you can separate, convert, filter, and amplify signals and cover all tasks of interference-free signal transmission. In intrinsically safe circuits, our Ex i signal conditioners and measuring transducers provide you with explosion protection in up to all zones and substance groups. In addition, products developed consistently for safety applications in accordance with IEC/EN 61508 and PL EN ISO 13849 ensure the safety of people, the environment, and the system.

COMPLETE line

Push-in Technology [®]

Designed by Phoenix Contact

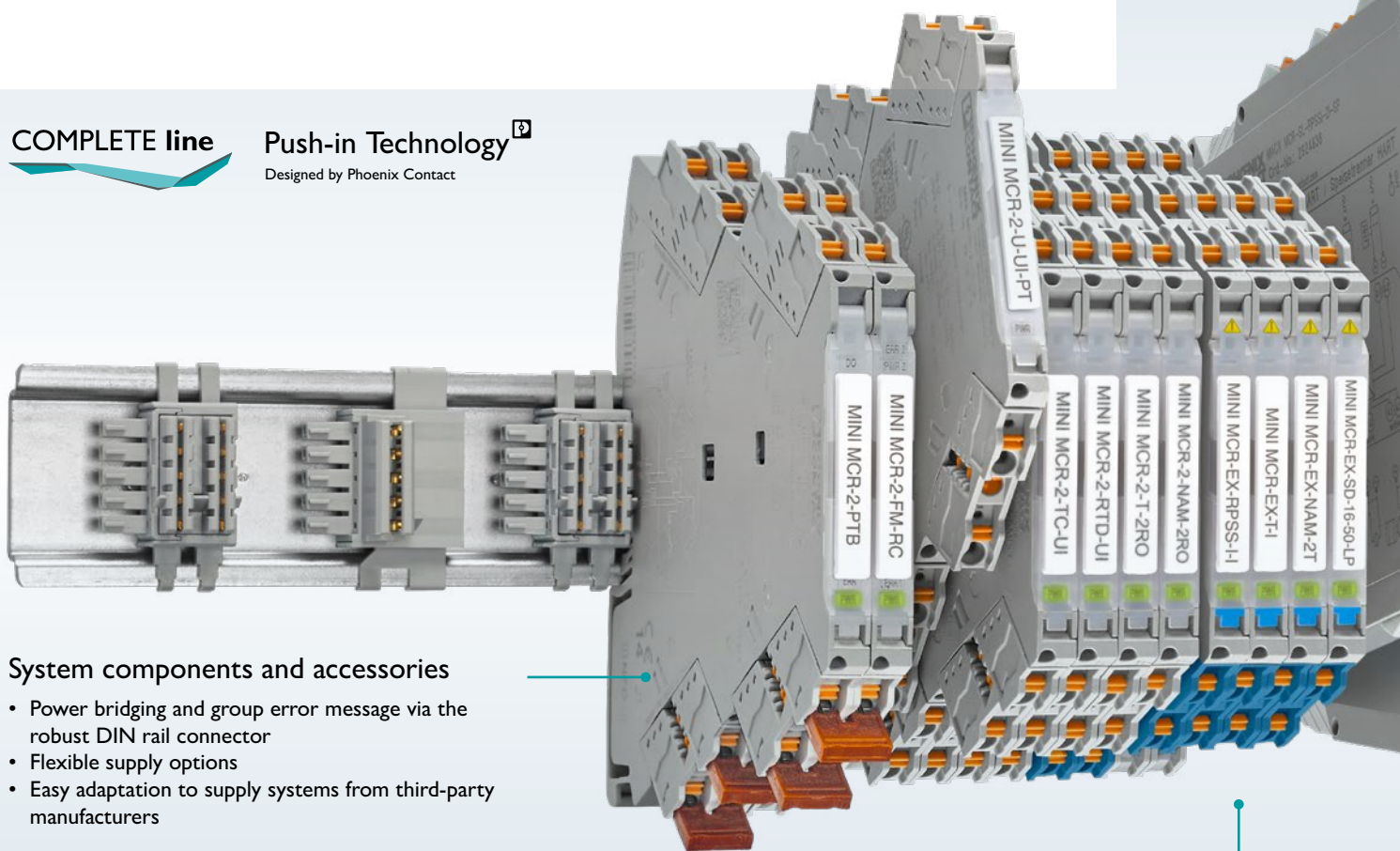

System components and accessories

- Power bridging and group error message via the robust DIN rail connector
- Flexible supply options
- Easy adaptation to supply systems from third-party manufacturers

GOLD at the German Innovation Award for the highly compact MINI Analog Pro Ex i signal conditioners with SIL 3.



Find out which of the MINI Analog Pro Ex i signal conditioners convinced the jury to award this innovation prize here.

Simply type the web code into the search field on our website.

i Web code: #3364

Highly compact MINI Analog Pro signal conditioners and measuring transducers for standard applications and explosion protection

- International Ex approvals, consistent extended temperature range
- Ex i versions with consistent suitability for SIL 3 applications
- User-friendly design and operating concept, end-to-end digitalization

MACX analog signal conditioners and measuring transducers for standard applications and explosion protection

- International Ex approvals
- Functional safety up to SIL 2 SC 3 or SIL 3, type-specific, versions with performance level
- Two-channel design, versions with wide range power supply

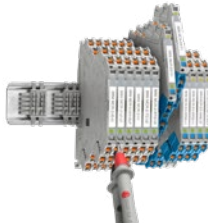
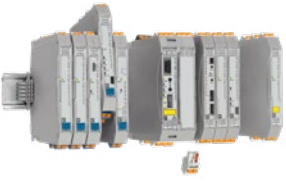

		
	MINI Analog Pro	MACX Analog
Versions for standard applications	•	•
Versions for Ex i and Ex ec explosion protection	•	•
Consistent SIL 3 1oo1 functional safety: AI, AO, DI, DO	•	-
Functional safety up to SIL 2 SC 3 or SIL 3, type-specific: AI, AO, DI, DO	-	•
PL d, PL c * functional safety	-	•
Two-channel design	-	•
Versions with wide range power supply	-	•
Uninterruptible measurement of the current loops	•	-
Plug-in gateways for fieldbus and network connection	•	-
Ambient temperature range of -40°C ... +70°C without derating	•	-
Information retrieval via Signal Conditioner App	NFC and QR code	QR code

Signal conditioners and measuring transducers with basic functionality

The 6-mm signal conditioners from the MINI Analog range offer the full spectrum of analog signal conditioning for standard applications. The products are reduced to the essentials in terms of space requirements and functionality.

You will find the products on our website under web code [#1135](#)

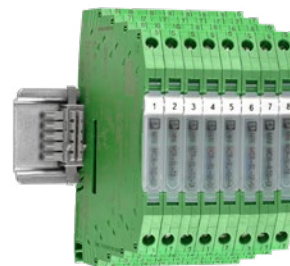

Signal conditioners and measuring transducers

Highly compact MINI Analog Pro signal conditioners and measuring transducers

Simple as ever, slim and safe as never before: The highly compact MINI Analog Pro signal conditioners and measuring transducers combine intrinsically safe explosion protection and functional safety up to SIL 3 1oo1 in an overall width of just 6.2 mm. In your application, benefit from the particularly user-friendly design and operating concept, the wide range of configuration options, and end-to-end digitalization.

COMPLETE line

Push-in Technology[®]
Designed by Phoenix Contact

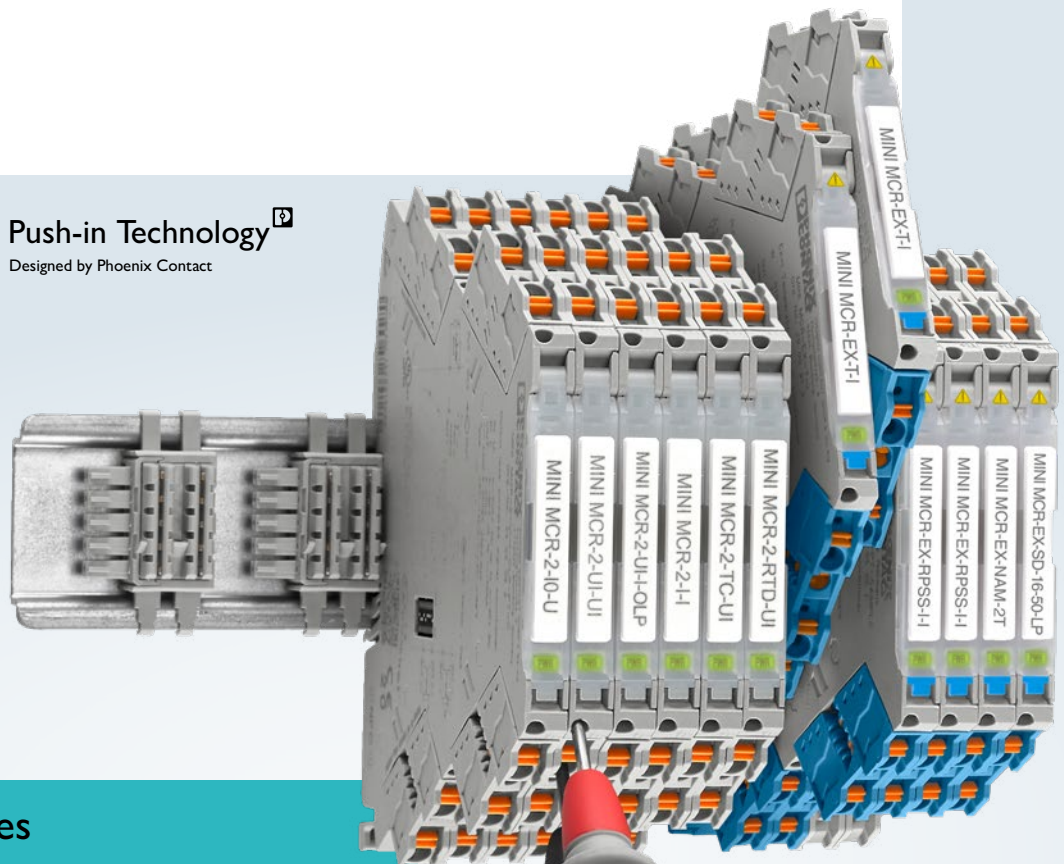

Your advantages

- ✓ Ex i and SIL 3 in a uniquely compact design in terms of overall width and height
- ✓ A safe solution up to SIL 3 1oo1 for every signal type and direction
- ✓ Easily accessible, pluggable connection terminal blocks with disconnect function
- ✓ User-friendly design and operating concept as well as versatile configuration options
- ✓ Ready for the digital future, with plug-in communication gateways and further digital services and features

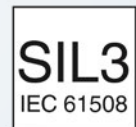

GOLD at the German Innovation Award for the highly compact MINI Analog Pro Ex i signal conditioners with SIL 3.



Find out which of the MINI Analog Pro features convinced the jury to award this innovation prize here.

Simply type the web code into the search field on our website.

Web code: #3364

Your advantages in detail

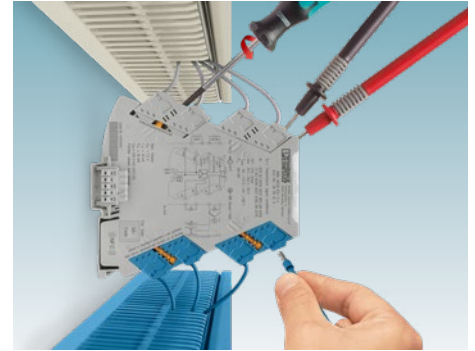
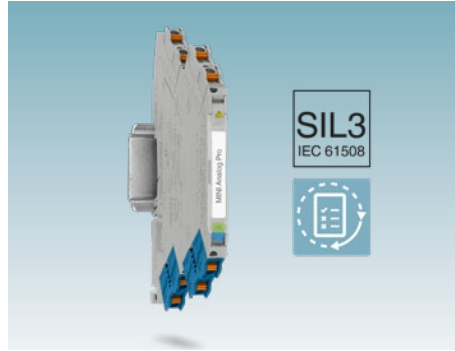
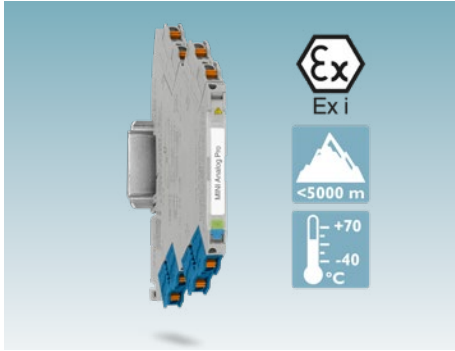

Explosion protection for all zones and substance groups

MINI Analog Pro Ex i signal conditioners have many international Ex approvals for use in up to all Ex zones and for all substance groups. Furthermore, mining approval, an extended temperature operating range of -40°C to $+70^{\circ}\text{C}$, and documented requirements for altitude operating ranges of up to 5000 m enable use in demanding environments.

A safe solution for every signal type and direction

The MINI Analog Pro Ex i signal conditioners are consistently SIL-certified and provide you with a comprehensive portfolio for all applications up to SIL 3 1oo1. Compared to SIL 2 devices, this has a positive effect on the calculation of your safety-related measuring circuit. At the same time, this also means reduced hardware requirements and prolonged proof test intervals.

User-friendly design and operating concept

Space-saving, even between the cable ducts: All connection elements are easily visible and accessible from the front. In addition, plug-in terminal blocks and power bridging with the DIN rail connector facilitate installation. Uninterruptible current signal measurement and a wide range of parameterization options simplify commissioning and service.

Product overview – MINI Analog Pro for standard applications and explosion protection

Analog IN/OUT

- Universal and standard signal conditioners
- HART®-transparent repeater power supplies and output signal conditioners
- Loop-powered signal conditioners

Temperature

- Universal measuring transducers for resistance thermometers
- Universal measuring transducers for thermocouples
- Universal temperature transducers for thermocouples and resistance thermometers

Frequency

- Universal measuring transducers with frequency or PWM input
- Universal analog frequency measuring transducers

Potentiometers

- Potentiometer measuring transducers with automatic potentiometer detection

Digital IN

- Signal conditioners for NAMUR sensors and floating contacts

Digital OUT

- Solenoid drivers with different output characteristics, loop-powered
- Solenoid drivers with 24 V DC supply voltage, different output characteristics and line fault detection

Limit values

- Limit value switches with relay changeover contact output

Accessories

- Plug-in communication gateways
- Partition plate for separating Ex i and non-Ex i signals
- Constant voltage source/ constant current source
- Supply components
- Fault monitoring module
- Marking material

Analog IN/OUT

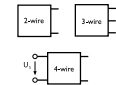

Temperature

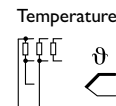

Frequency

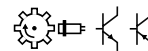

Potentiometer

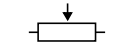

Digital IN

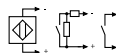



Digital OUT



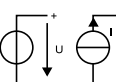

Limit values

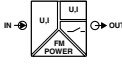

Product overview – MINI Analog Pro for standard applications

Analog IN/OUT			
			
Product type	Signal conditioner		
			
Description	Universal 4-way signal conditioner with switching output, configurable		
			
Approvals			
Ex installation / Ex i switching circuit	Gc; Div. 2		
Input signal	0 mA ... 24 mA (freely adjustable) 0 V ... 12 V (freely adjustable)		
Output signal	0 mA ... 21 mA (freely adjustable) 0 V ... 10.5 V (freely adjustable)		
Switching output	Switching output (1 N/O contact)		
Supply voltage	9.6 V DC ... 30 V DC		
Ambient temperature range	-40°C ... +70°C		
Fault signaling: LED	Yes		
Fault monitoring	Wire break / short circuit / over-range / under-range / device error		
System adapter (optional)	2901993 MINI MCR-2-V8-FLK 16		
Gateway (optional)	2905634 MINI MCR-2-V8-MOD-RTU / 2905635 MINI MCR-2-V8-MOD-TCP / 2905636 MINI MCR-2-V8-PB-DP / 2905637 MINI MCR-2-V8-PN		
Termination Carrier (optional)	2906640 TC-D37SUB-AIO16-MP-PS-UNI / 2906639 TC-D37SUB-ADIO16-MP-P-UNI		
Configuration	DIP switch / software / app		
Width	6.2 mm		
Delivery state	Standard configuration		Order configuration
Type	MINI MCR-2-UNI-UI-UIRO(-PT)		MINI MCR-2-UNI-UI-UIRO(-PT)-C
Connection method	Push-in connection	Screw connection	Push-in connection Screw connection
Item number	2902028	2902026	2902027 2902024

 The module can be snapped onto the DIN rail connector for 24 V voltage bridging

 Wide range input for worldwide supply networks

 Module information:
• Access module information

Product overview – MINI Analog Pro for standard applications

1

2

3

Signal conditioners and measuring transducers

Analog IN/OUT								
Product type	Signal conditioner							
Description	3-way signal conditioner, configurable							
Approvals								
Ex installation / Ex i switching circuit	Gc; Div. 2							
Input signal	0 mA ... 20 mA / 4 mA ... 20 mA / -20 mA ... 20 mA / 0 V ... 5 V / 1 V ... 5 V / -5 V ... 5 V / 0 V ... 10 V / 2 V ... 10 V / -10 V ... 10 V / 0 V ... 20 V / 4 V ... 20 V / -20 V ... 20 V / 0 V ... 24 V / 4.8 V ... 24 V / -24 V ... 24 V / 0 V ... 30 V / 6 V ... 30 V / -30 V ... 30 V				Unipolar and bipolar (28 ranges each): 0 mV ... 50 mV to 0 V ... 30 V +/-50 mV to +/-30 V			
Output signal	0 mA ... 20 mA / 4 mA ... 20 mA / 0 V ... 5 V / 1 V ... 5 V / -5 V ... 5 V / 0 V ... 10 V / 2 V ... 10 V / -10 V ... 10 V							
Supply voltage	9.6 V DC ... 30 V DC							
Ambient temperature range	-40°C ... +70°C							
Fault signaling: LED	No							
Fault monitoring	Device error							
System adapter (optional)	2901993 MINI MCR-2-V8-FLK 16							
Gateway (optional)	2905634 MINI MCR-2-V8-MOD-RTU / 2905635 MINI MCR-2-V8-MOD-TCP / 2905636 MINI MCR-2-V8-PB-DP / 2905637 MINI MCR-2-V8-PN							
Termination Carrier (optional)	2906640 TC-D37SUB-AIO16-MP-PS-UNI / 2906639 TC-D37SUB-ADIO16-MP-P-UNI							
Configuration	DIP switch							
Width	6.2 mm							
Delivery state	Standard configuration		Order configuration		Standard configuration		Order configuration	
Type	MINI MCR-2-UI-UI(-PT)		MINI MCR-2-UI-UI(-PT)-C		MINI MCR-2-U-UI(-PT)		MINI MCR-2-U-UI(-PT)-C	
Connection method	Push-in connection	Screw connection	Push-in connection	Screw connection	Push-in connection	Screw connection	Push-in connection	Screw connection
Item number	2902040	2902037	2902039	2902036	2902021	2902019	2902020	2902018















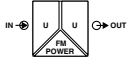
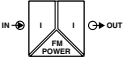
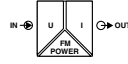
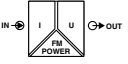















DIP switch setting help:
 • Access module information
 • DIP switch setting help





Configuration
 • Access module information
 • DIP switch setting help
 • Module configuration
 • Bluetooth communication

Product overview – MINI Analog Pro for standard applications

Analog IN/OUT												
												
Product type	Signal conditioner											
												
Description	3-way signal conditioner with fixed signal combinations											
	   											
Approvals	       			         								
Ex installation / Ex i switching circuit	Gc; Div. 2											
Signal transmission behavior	In = out											
Input signal	0 V ... 10 V / -10 V ... 10 V / 2 V ... 10 V		0 mA ... 20 mA / 4 mA ... 20 mA		0 V ... 10 V				0 mA ... 20 mA		4 mA ... 20 mA	
Output signal	0 V ... 10 V / -10 V ... 10 V		0 mA ... 20 mA / 4 mA ... 20 mA		0 mA ... 20 mA		4 mA ... 20 mA		0 V ... 10 V			
Supply voltage	9.6 V DC ... 30 V DC											
Ambient temperature range	-40°C ... +70°C											
Fault signaling: LED	No											
Fault monitoring	Device error											
System adapter (optional)	2901993 MINI MCR-2-V8-FLK 16											
Gateway (optional)	2905634 MINI MCR-2-V8-MOD-RTU / 2905635 MINI MCR-2-V8-MOD-TCP / 2905636 MINI MCR-2-V8-PB-DP / 2905637 MINI MCR-2-V8-PN											
Termination Carrier (optional)	2906640 TC-D37SUB-AIO16-MP-PS-UNI / 2906639 TC-D37SUB-ADIO16-MP-P-UNI											
Width	6.2 mm											
Delivery state	Standard configuration											
Type	MINI MCR-2-U-U(-PT)		MINI MCR-2-I-I(-PT)		MINI MCR-2-U-I0(-PT)		MINI MCR-2-U-I4(-PT)		MINI MCR-2-I0-U(-PT)		MINI MCR-2-I4-U(-PT)	
Connection method	Push-in connection	Screw connection	Push-in connection	Screw connection	Push-in connection	Screw connection	Push-in connection	Screw connection	Push-in connection	Screw connection	Push-in connection	Screw connection
Item number	2902043	2902042	2901999	2901998	2902023	2902022	2902030	2902029	2902001	2902000	2902003	2902002

 The module can be snapped onto the DIN rail connector for 24 V voltage bridging

 Wide range input for worldwide supply networks

 Module information:
• Access module information









Product overview – MINI Analog Pro for standard applications

1

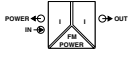
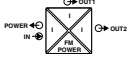
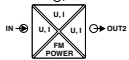
2

3

Signal conditioners and measuring transducers

Analog IN/OUT								
								
Product type	Repeater power supply				Signal duplicator			
								
Description	3-way repeater power supply, HART-transparent		4-way supply duplicator, HART-transparent		Universal 4-way signal duplicator, configurable			
								
Approvals								
Ex installation / Ex i switching circuit	Gc; Div. 2							
Signal transmission behavior	In = out							
Input signal	0 mA ... 20 mA / 4 mA ... 20 mA				0 mA ... 24 mA (freely adjustable) 0 V ... 12 V (freely adjustable)			
Output signal	0 mA ... 20 mA / 4 mA ... 20 mA				0 mA ... 21 mA (freely adjustable) 0 V ... 10.5 V (freely adjustable)			
Supply voltage	9.6 V DC ... 30 V DC							
Ambient temperature range	-40°C ... +70°C							
Fault signaling: LED	No				Yes			
Fault monitoring	Device error				Wire break / short circuit / over-range / under-range / device error			
System adapter (optional)	2901993 MINI MCR-2-V8-FLK 16							
Gateway (optional)	2905634 MINI MCR-2-V8-MOD-RTU / 2905635 MINI MCR-2-V8-MOD-TCP / 2905636 MINI MCR-2-V8-PB-DP / 2905637 MINI MCR-2-V8-PN							
Termination Carrier (optional)	2906640 TC-D37SUB-AIO16-MP-PS-UNI / 2906639 TC-D37SUB-ADIO16-MP-P-UNI							
Configuration	DIP switch				DIP switch / software / app			
Width	6.2 mm							
Delivery state	Standard configuration						Order configuration	
Type	MINI MCR-2-RPSS-I-I(-PT)		MINI MCR-2-RPSS-I-2I(-PT)		MINI MCR-2-UNI-UI-2UI(-PT)		MINI MCR-2-UNI-UI-2UI(-PT)-C	
Connection method	Push-in connection	Screw connection	Push-in connection	Screw connection	Push-in connection	Screw connection	Push-in connection	Screw connection
Item number	2902015	2902014	2905629	2905628	2905028	2905026	2905027	2905025



DIP switch setting help:

- Access module information
- DIP switch setting help



Configuration

- Access module information
- DIP switch setting help
- Module configuration
- Bluetooth communication

Product overview – MINI Analog Pro for standard applications

Analog IN/OUT								
Product type	Signal conditioner							
Description	Input loop-powered 2-way isolator, 1-channel		Input loop-powered 2-way isolator, 2-channel		Output loop-powered 2-way isolator			
Approvals								
Ex installation / Ex i switching circuit	Gc; Div. 2							
Signal transmission behavior	In = out							
Input signal	0 mA ... 20 mA / 4 mA ... 20 mA				Unipolar and bipolar: 0 mA ... 2 mA to 0 mA ... 40 mA (16 ranges) 0 mV ... 50 mV to 0 V ... 30 V (58 ranges)			
Output signal	0 mA ... 20 mA / 4 mA ... 20 mA				4 mA ... 20 mA			
Supply voltage	Loop-powered, no external supply necessary							
Ambient temperature range	-40°C ... +70°C							
Fault signaling: LED	No							
System adapter (optional)	2901993 MINI MCR-2-V8-FLK 16							
Gateway (optional)	2905634 MINI MCR-2-V8-MOD-RTU / 2905635 MINI MCR-2-V8-MOD-TCP / 2905636 MINI MCR-2-V8-PB-DP / 2905637 MINI MCR-2-V8-PN							
Termination Carrier (optional)	2906640 TC-D37SUB-AIO16-MP-PS-UNI / 2906639 TC-D37SUB-ADIO16-MP-P-UNI							
Configuration					DIP switch			
Width	6.2 mm							
Delivery state	Standard configuration						Order configuration	
Type	MINI MCR-2-I-I-ILP(-PT)		MINI MCR-2-2I-2I-ILP(-PT)		MINI MCR-2-UI-I-OLP(-PT)		MINI MCR-2-UI-I-OLP(-PT)-C	
Connection method	Push-in connection	Screw connection	Push-in connection	Screw connection	Push-in connection	Screw connection	Push-in connection	Screw connection
Item number	2901995	2901994	2901997	2901996	2902063	2902061	2902062	2902060

The module can be snapped onto the DIN rail connector for 24 V voltage bridging

Wide range input for worldwide supply networks

Module information:
• Access module information





Product overview – MINI Analog Pro for standard applications

1

2

3

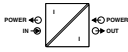
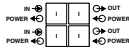
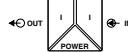
Signal conditioners and measuring transducers

Analog IN/OUT						
						
Product type	Repeater power supply				Output signal conditioner	
						
Description	Output loop-powered 2-way isolator, 1-channel		Output loop-powered 2-way isolator, 2-channel		Output signal conditioner, HART-transparent	
Approvals						
Ex installation / Ex i switching circuit	Gc; Div. 2					
Signal transmission behavior	In = out					
Input signal	0 mA ... 20 mA / 4 mA ... 20 mA					
Output signal	0 mA ... 20 mA / 4 mA ... 20 mA					
Supply voltage	Loop-powered, no external supply necessary				19.2 V DC ... 30 V DC	
Ambient temperature range	-40°C ... +70°C					
Fault signaling: LED	No					
Fault monitoring					Wire break / short circuit / over-range / under-range / device error	
System adapter (optional)	2901993 MINI MCR-2-V8-FLK 16					
Termination Carrier (optional)	2906640 TC-D37SUB-AIO16-MP-PS-UNI / 2906639 TC-D37SUB-ADIO16-MP-P-UNI					
Configuration					DIP switch	
Width	6.2 mm					
Delivery state	Standard configuration					
Type	MINI MCR-2-RPS-I-I-OLP(-PT)		MINI MCR-2-RPS-2I-2I-OLP(-PT)		MINI MCR-2-IDS-I-I(-PT)	
Connection method	Push-in connection	Screw connection	Push-in connection	Screw connection	Push-in connection	Screw connection
Item number	2906447	2906446	2906449	2906448	2905625 new	2905623 new





- DIP switch setting help:
- Access module information
 - DIP switch setting help



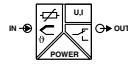

- Configuration
- Access module information
 - DIP switch setting help
 - Module configuration
 - Bluetooth communication

Product overview – MINI Analog Pro for standard applications

Temperature			
			
Product type	Temperature transducer		
			
Description	Universal temperature transducer, configurable		
			
Ex installation / Ex i switching circuit	Gc; Div. 2		
Usable input source	RTD: Pt, Ni, Cu sensors / TC: B, E, J, K, N, R, S, T, L, U, A-1, A-2, A-3, M, L		
Input signal	-250°C ... 2500°C (range depending on the sensor type) / linear resistance: 0 Ω ... 40 kΩ / potentiometer: 0 Ω ... 40 kΩ / -1000 mV ... 1000 mV		
Output signal	0 mA ... 20 mA / 4 mA ... 20 mA / 20 mA ... 0 mA / 20 mA ... 4 mA		
Supply voltage	19.2 V DC ... 30 V DC		
Ambient temperature range	-40°C ... +70°C		
Fault signaling: LED	Yes		
Fault monitoring	Wire break / short circuit / over-range / under-range / device error		
System adapter (optional)	2901993 MINI MCR-2-V8-FLK 16		
Gateway (optional)	2905634 MINI MCR-2-V8-MOD-RTU / 2905635 MINI MCR-2-V8-MOD-TCP / 2905636 MINI MCR-2-V8-PB-DP / 2905637 MINI MCR-2-V8-PN		
Termination Carrier (optional)	2906640 TC-D37SUB-AIO16-MP-PS-UNI / 2906639 TC-D37SUB-ADIO16-MP-P-UNI		
Configuration	Software / app		
Width	6.2 mm		
Delivery state	Standard configuration		Order configuration
Type	MINI MCR-2-T-I(-PT)		MINI MCR-2-T-I(-PT)-C
Connection method	Push-in connection	Screw connection	Push-in connection / Screw connection
Item number	2908829 new	2908828 new	1472070 new / 1472071 new

 The module can be snapped onto the DIN rail connector for 24 V voltage bridging

 Wide range input for worldwide supply networks

 Module information:
• Access module information













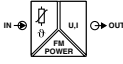
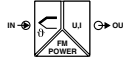

















Product overview – MINI Analog Pro for standard applications

1

2

3

Signal conditioners and measuring transducers

Temperature								
								
Product type	Temperature transducer							
								
Description	Universal measuring transducer for 2-, 3-, 4-conductor RTDs, configurable				Universal measuring transducer for TC, configurable			
	   							
Approvals	     		     		     		     	
Ex installation / Ex i switching circuit	Gc; Div. 2							
Usable input source	RTD: Pt, Ni, Cu sensors / 2, 3, 4-conductor				TC: B, C, E, J, K, N, R, S, T, L, U, A-1, A-2, A-3, M, L			
Input signal	-200°C ... 850°C (range depending on sensor type, range can be set freely via software or in increments from -150°C to 850°C via DIP switches) / linear resistance: 0 Ω ... 4000 Ω (minimum measuring span: 10% of the selected measuring range)				-250°C ... 2500°C (range depending on sensor type, range can be set freely via software or in increments from -150°C to 1350°C via DIP switches) / -500 mV ... 500 mV (can be set via software)			
Output signal	0 mA ... 21 mA (freely adjustable) 0 V ... 10.5 V (freely adjustable)							
Supply voltage	9.6 V DC ... 30 V DC							
Ambient temperature range	-40°C ... +70°C							
Fault signaling: LED	Yes							
Fault monitoring	Wire break / short circuit / over-range / under-range / device error							
System adapter (optional)	2901993 MINI MCR-2-V8-FLK 16							
Gateway (optional)	2905634 MINI MCR-2-V8-MOD-RTU / 2905635 MINI MCR-2-V8-MOD-TCP / 2905636 MINI MCR-2-V8-PB-DP / 2905637 MINI MCR-2-V8-PN							
Termination Carrier (optional)	2906640 TC-D37SUB-AIO16-MP-PS-UNI / 2906639 TC-D37SUB-ADIO16-MP-P-UNI							
Configuration	DIP switch / software / app							
Width	6.2 mm							
Delivery state	Standard configuration		Order configuration		Standard configuration		Order configuration	
Type	MINI MCR-2-RTD-UI(-PT)		MINI MCR-2-RTD-UI(-PT)-C		MINI MCR-2-TC-UI(-PT)		MINI MCR-2-TC-UI(-PT)-C	
Connection method	Push-in connection	Screw connection	Push-in connection	Screw connection	Push-in connection	Screw connection	Push-in connection	Screw connection
Item number	2902052	2902049	2902051	2902048	2905249	2902055	2905248	2902053



DIP switch setting help:

- Access module information
- DIP switch setting help



Configuration

- Access module information
- DIP switch setting help
- Module configuration
- Bluetooth communication

Product overview – MINI Analog Pro for standard applications

Frequency								
Product type	Frequency transducer							
Description	Frequency transducer / limit value switch, configurable				Analog frequency transducer / limit value switch, configurable			
Approvals								
Ex installation / Ex i switching circuit	Gc; Div. 2							
Usable input source	NAMUR initiator / NPN/PNP transistor outputs / floating contact (dry contact) / frequency generator / incremental encoder (speed only) / HTL rotary transducer / TTL rotary transducer / S0 signal							
Input signal	Frequency: 0.002 Hz ... 200 kHz PWM: 2% ... 98%				0 mA ... 24 mA (freely adjustable) 0 V ... 12 V (freely adjustable)			
Output signal	0 mA ... 21 mA (freely adjustable) 0 V ... 10.5 V (freely adjustable)				Frequency: 0 kHz ... 10 kHz (freely adjustable) PWM: 0% ... 100%			
Switching output	Switching output (1 N/O contact)							
Supply voltage	9.6 V DC ... 30 V DC							
Ambient temperature range	-40°C ... +70°C							
Fault signaling: LED	Yes							
Fault monitoring	Wire break / short circuit / over-range / under-range / device error							
System adapter (optional)	2901993 MINI MCR-2-V8-FLK 16							
Gateway (optional)	2905634 MINI MCR-2-V8-MOD-RTU / 2905635 MINI MCR-2-V8-MOD-TCP / 2905636 MINI MCR-2-V8-PB-DP / 2905637 MINI MCR-2-V8-PN							
Termination Carrier (optional)	2906640 TC-D37SUB-AIO16-MP-PS-UNI / 2906639 TC-D37SUB-ADIO16-MP-P-UNI							
Configuration	DIP switch / software / app							
Width	6.2 mm							
Delivery state	Standard configuration		Order configuration		Standard configuration		Order configuration	
Type	MINI MCR-2-F-UI(-PT)		MINI MCR-2-F-UI(-PT)-C		MINI MCR-2-UI-FRO(-PT)		MINI MCR-2-UI-FRO(-PT)-C	
Connection method	Push-in connection	Screw connection	Push-in connection	Screw connection	Push-in connection	Screw connection	Push-in connection	Screw connection
Item number	2902058	2902056	2902059	2902057	2902032	2902031	2906202	2906201

The module can be snapped onto the DIN rail connector for 24 V voltage bridging

Wide range input for worldwide supply networks

NFC Module information:
• Access module information



Product overview – MINI Analog Pro for standard applications

1

2

3

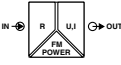
Signal conditioners and measuring transducers

Potentiometers			
			
Product type	Potentiometer measuring transducer		
			
Description	Potentiometer measuring transducer, configurable		
Approvals			
Ex installation / Ex i switching circuit	Gc; Div. 2		
Usable input source	3-wire potentiometer		
Input signal	0 Ω ... 100 Ω / 0 Ω ... 100 kΩ		
Output signal	0 mA ... 21 mA (freely adjustable) 0 V ... 10.5 V (freely adjustable)		
Supply voltage	9.6 V DC ... 30 V DC		
Ambient temperature range	-40°C ... +70°C		
Fault signaling: LED	Yes		
Fault monitoring	Wire break / over-range / under-range / device error		
System adapter (optional)	2901993 MINI MCR-2-V8-FLK 16		
Gateway (optional)	2905634 MINI MCR-2-V8-MOD-RTU / 2905635 MINI MCR-2-V8-MOD-TCP / 2905636 MINI MCR-2-V8-PB-DP / 2905637 MINI MCR-2-V8-PN		
Termination Carrier (optional)	2906640 TC-D37SUB-AIO16-MP-PS-UNI / 2906639 TC-D37SUB-ADIO16-MP-P-UNI		
Configuration	DIP switch / software / app		
Width	6.2 mm		
Delivery state	Standard configuration		Order configuration
Type	MINI MCR-2-POT-UI(-PT)		MINI MCR-2-POT-UI(-PT)-C
Connection method	Push-in connection	Screw connection	Push-in connection / Screw connection
Item number	2902017	2902016	2905006 / 2905005



DIP switch setting help:

- Access module information
- DIP switch setting help



Configuration

- Access module information
- DIP switch setting help
- Module configuration
- Bluetooth communication

Product overview – MINI Analog Pro for standard applications

1

2

3

Signal conditioners and measuring transducers

Limit values								
Product type	Limit value switch							
Description	Limit value switch, configurable				Universal limit value switch for 2-, 3-, 4-conductor RTDs and TCs, configurable			
Approvals								
Ex installation / Ex i switching circuit	Gc; Div. 2							
Usable input source					RTD: Pt, Ni, Cu sensors / TC: B, E, J, K, N, R, S, T, L, U, A-1, A-2, A-3, M, L			
Input signal	0 mA ... 24 mA (freely adjustable) 0 V ... 12 V (freely adjustable)				-200°C ... 850°C (depending on sensor) linear resistance: 0 ... 4 kΩ -250°C ... 2500°C (depending on sensor)			
Switching output	Relay output (1 changeover contact)				Relay output (1 N/O contact)		Switching output (2 N/O contacts)	
Supply voltage	9.6 V DC ... 30 V DC							
Ambient temperature range	-40°C ... +70°C							
Fault signaling: LED	Yes							
Fault monitoring	Over-range / under-range / device error				Wire break / short circuit / over-range / under-range / device error			
System adapter (optional)					2901993 MINI MCR-2-V8-FLK 16			
Gateway (optional)					2905634 MINI MCR-2-V8-MOD-RTU / 2905635 MINI MCR-2-V8-MOD-TCP / 2905636 MINI MCR-2-V8-PB-DP / 2905637 MINI MCR-2-V8-PN			
Termination Carrier (optional)	2906640 TC-D37SUB-AIO16-MP-PS-UNI / 2906639 TC-D37SUB-ADIO16-MP-P-UNI							
Configuration	DIP switch / software / app							
Width	6.2 mm							
Delivery state	Standard configuration		Order configuration		Standard configuration			
Type	MINI MCR-2-UI-REL(-PT)		MINI MCR-2-UI-REL(-PT)-C		MINI MCR-2-T-REL(-PT)		MINI MCR-2-T-2RO(-PT)	
Connection method	Push-in connection	Screw connection	Push-in connection	Screw connection	Push-in connection	Screw connection	Push-in connection	Screw connection
Item number	2902035	2902033	2909887	2909886	2905633	2905632	2906877	2906876



- DIP switch setting help:
- Access module information
 - DIP switch setting help



- Configuration
- Access module information
 - DIP switch setting help
 - Module configuration
 - Bluetooth communication





Product overview – MINI Analog Pro for explosion protection

1

2

3

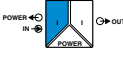
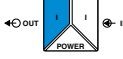
Signal conditioners and measuring transducers

Analog IN/OUT			
			
Product type	Repeater power supply		Output signal conditioner
			
Description	Ex i repeater power supply, HART-transparent		Ex i output signal conditioner, HART-transparent
			
Ex installation / Ex i switching circuit	Gc; Div. 2 / Ga; Da; Ma; Div. 1		
Functional safety	SIL 3		
Signal transmission behavior	In = out		
Input signal	0 mA ... 20 mA / 4 mA ... 20 mA		
Output signal	0 mA ... 20 mA / 4 mA ... 20 mA		
Supply voltage	19.2 V DC ... 30 V DC		
Ambient temperature range	-40°C ... +70°C		
Fault signaling: LED	No		
Fault monitoring	Wire break / short circuit / over-range / under-range / device error		
System adapter (optional)	2901993 MINI MCR-2-V8-FLK 16		
Gateway (optional)	2905634 MINI MCR-2-V8-MOD-RTU / 2905635 MINI MCR-2-V8-MOD-TCP / 2905636 MINI MCR-2-V8-PB-DP / 2905637 MINI MCR-2-V8-PN		
Termination Carrier (optional)	2906640 TC-D37SUB-AIO16-MP-PS-UNI / 2906639 TC-D37SUB-ADIO16-MP-P-UNI		
Configuration	DIP switch		
Width	6.2 mm		
Delivery state	Standard configuration		
Type	MINI MCR-EX-RPSS-I-I(-PT)		MINI MCR-EX-IDS-I-I(-PT)
Connection method	Push-in connection	Screw connection	Push-in connection / Screw connection
Item number	2908804 new	2908803 new	2908806 new / 2908805 new





- DIP switch setting help:
- Access module information
 - DIP switch setting help



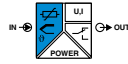

- Configuration
- Access module information
 - DIP switch setting help
 - Module configuration
 - Bluetooth communication

Product overview – MINI Analog Pro for explosion protection

Temperature			
			
Product type	Temperature transducer		
			
Description	Universal Ex i temperature transducer, configurable		
			
Ex installation / Ex i switching circuit	Gc; Div. 2 / Ga; Da; Ma; Div. 1		
Functional safety	SIL 3		
Usable input source	RTD: Pt, Ni, Cu sensors / TC: B, E, J, K, N, R, S, T, L, U, A-1, A-2, A-3, M, L		
Input signal	-250°C ... 2500°C (range depending on the sensor type) / linear resistance: 0 Ω ... 40 kΩ / potentiometer: 0 Ω ... 40 kΩ / -1000 mV ... 1000 mV		
Output signal	0 mA ... 20 mA / 4 mA ... 20 mA / 20 mA ... 0 mA / 20 mA ... 4 mA		
Supply voltage	19.2 V DC ... 30 V DC		
Ambient temperature range	-40°C ... +70°C		
Fault signaling: LED	Yes		
Fault monitoring	Wire break / short circuit / over-range / under-range / device error		
System adapter (optional)	2901993 MINI MCR-2-V8-FLK 16		
Gateway (optional)	2905634 MINI MCR-2-V8-MOD-RTU / 2905635 MINI MCR-2-V8-MOD-TCP / 2905636 MINI MCR-2-V8-PB-DP / 2905637 MINI MCR-2-V8-PN		
Termination Carrier (optional)	2906640 TC-D37SUB-AIO16-MP-PS-UNI / 2906639 TC-D37SUB-ADIO16-MP-P-UNI		
Configuration	Software / app		
Width	6.2 mm		
Delivery state	Standard configuration		Order configuration
Type	MINI MCR-EX-T-I(-PT)		MINI MCR-EX-T-I(-PT)-C
Connection method	Push-in connection	Screw connection	Push-in connection / Screw connection
Item number	2908814 new	2908813 new	1472132 new / 1472072 new

 The module can be snapped onto the DIN rail connector for 24 V voltage bridging

 Wide range input for worldwide supply networks

 Module information:
• Access module information

Product overview – MINI Analog Pro for explosion protection

1

2

3

Signal conditioners and measuring transducers

Digital IN						
Product type	Signal conditioner					
Description	Ex i NAMUR signal conditioner, configurable					
Ex installation / Ex i switching circuit	Gc; Div. 2 / Ga; Da; Ma; Div. 1					
Functional safety	SIL 3					
Usable input source	NAMUR proximity sensors (IEC/EN 60947-5-6) / floating switch contacts / switching contacts with resistance circuits					
Switching output	Transistor output (passive)			Relay output (solid-state relay)		
Supply voltage	19.2 V DC ... 30 V DC					
Ambient temperature range	-40°C ... +70°C					
Fault signaling: LED	Yes					
Fault monitoring	Wire break / short circuit / device error					
System adapter (optional)	2901993 MINI MCR-2-V8-FLK 16					
Gateway (optional)	2905634 MINI MCR-2-V8-MOD-RTU / 2905635 MINI MCR-2-V8-MOD-TCP / 2905636 MINI MCR-2-V8-PB-DP / 2905637 MINI MCR-2-V8-PN					
Termination Carrier (optional)	2906640 TC-D37SUB-AIO16-MP-PS-UNI / 2906639 TC-D37SUB-ADIO16-MP-P-UNI					
Configuration	DIP switch					
Width	6.2 mm					
Delivery state	Standard configuration					
Type	MINI MCR-EX-NAM-T(-PT)		MINI MCR-EX-NAM-2T(-PT)		MINI MCR-EX-NAM-RO(-PT)	
Connection method	Push-in connection	Screw connection	Push-in connection	Screw connection	Push-in connection	Screw connection
Item number	2908808 new	2908807 new	1157854 new	1157852 new	1157857 new	1157862 new





- DIP switch setting help:
- Access module information
 - DIP switch setting help



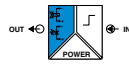

- Configuration
- Access module information
 - DIP switch setting help
 - Module configuration
 - Bluetooth communication

Product overview – MINI Analog Pro for explosion protection



Digital OUT								
								
Product type	Solenoid driver							
								
Description	Solenoid driver, with logic input and line fault detection, current limitation at 50 mA		Solenoid driver, with logic input and line fault detection, current limitation at 25 mA		Solenoid driver, with logic input and line fault detection, current limitation at 48 mA		Solenoid driver, with logic input and line fault detection, current limitation at 38 mA	
								
Ex installation / Ex i switching circuit	Gc; Div. 2 / Ga; Da; Ma; Div. 1							
Functional safety	SIL 3							
Input signal	Switching level "0" signal: 0 V ... 5 V / Switching level "1" signal: 15 V ... 30 V							
Output signal	Output voltage: ≥10.7 V DC (50 mA) / no-load voltage: >16 V / current limitation: >50 mA (with line fault detection) / output resistance: ≥103 Ω (internal resistance Ri)	Output voltage: ≥9.6 V DC (25 mA) / no-load voltage: >20 V / current limitation: >25 mA (with line fault detection) / output resistance: ≥413 Ω (internal resistance Ri)	Output voltage: ≥12.2 V DC (48 mA) / no-load voltage: >21 V / current limitation: >48 mA (with line fault detection) / output resistance: ≥181 Ω (internal resistance Ri)	Output voltage: ≥12.5 V DC (38 mA) / no-load voltage: >23 V / current limitation: >38 mA (with line fault detection) / output resistance: ≥270 Ω (internal resistance Ri)				
Supply voltage	19.2 V DC ... 30 V DC							
Ambient temperature range	-40°C ... +70°C							
Fault signaling: LED	Yes							
Fault monitoring	Wire break / short circuit / device error							
System adapter (optional)	2901993 MINI MCR-2-V8-FLK 16							
Termination Carrier (optional)	2906640 TC-D37SUB-AIO16-MP-PS-UNI / 2906639 TC-D37SUB-ADIO16-MP-P-UNI							
Width	6.2 mm							
Delivery state	Standard configuration							
Type	MINI MCR-EX-SD-16-50-LFD(-PT)		MINI MCR-EX-SD-20-25-LFD(-PT)		MINI MCR-EX-SD-21-48-LFD(-PT)		MINI MCR-EX-SD-23-38-LFD(-PT)	
Connection method	Push-in connection	Screw connection	Push-in connection	Screw connection	Push-in connection	Screw connection	Push-in connection	Screw connection
Item number	1175904 new	1175902 new	1175897 new	1175891 new	1175884 new	1175877 new	1277119 new	1277116 new

 The module can be snapped onto the DIN rail connector for 24 V voltage bridging

 Wide range input for worldwide supply networks

 Module information:
• Access module information

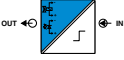
Product overview – MINI Analog Pro for explosion protection

Digital OUT								
								
Product type	Solenoid driver							
								
Description	Solenoid driver, loop-powered, current limitation at 50 mA		Solenoid driver, loop-powered, current limitation at 25 mA		Solenoid driver, loop-powered, current limitation at 48 mA		Solenoid driver, loop-powered, current limitation at 38 mA	
								
Ex installation / Ex i switching circuit	Gc; Div. 2 / Ga; Da; Ma; Div. 1							
Functional safety	SIL 3							
Input signal	19.2 V DC ... 30 V DC							
Output signal	Output voltage: ≥ 10.7 V DC (50 mA) / no-load voltage: > 16 V / current limitation: > 50 mA / output resistance: $\geq 103 \Omega$ (internal resistance Ri)		Output voltage: ≥ 9.6 V DC (25 mA) / no-load voltage: > 20 V / current limitation: > 25 mA / output resistance: $\geq 413 \Omega$ (internal resistance Ri)		Output voltage: ≥ 12.2 V DC (48 mA) / no-load voltage: > 21 V / current limitation: > 48 mA / output resistance: $\geq 181 \Omega$ (internal resistance Ri)		Output voltage: ≥ 12.5 V DC (38 mA) / no-load voltage: > 23 V / current limitation: > 38 mA / output resistance: $\geq 270 \Omega$ (internal resistance Ri)	
Supply voltage	Loop-powered, no external supply necessary							
Ambient temperature range	$-40^{\circ}\text{C} \dots +70^{\circ}\text{C}$							
Fault signaling: LED	No							
System adapter (optional)	2901993 MINI MCR-2-V8-FLK 16							
Termination Carrier (optional)	2906640 TC-D37SUB-AIO16-MP-PS-UNI / 2906639 TC-D37SUB-ADIO16-MP-P-UNI							
Width	6.2 mm							
Delivery state	Standard configuration							
Type	MINI MCR-EX-SD-16-50-LP(-PT)		MINI MCR-EX-SD-20-25-LP(-PT)		MINI MCR-EX-SD-21-48-LP(-PT)		MINI MCR-EX-SD-23-38-LP(-PT)	
Connection method	Push-in connection	Screw connection	Push-in connection	Screw connection	Push-in connection	Screw connection	Push-in connection	Screw connection
Item number	1157870 new	1157869 new	1157868 new	1157867 new	2908811 new	2908810 new	1277114 new	1277111 new



- DIP switch setting help:
- Access module information
 - DIP switch setting help



- Configuration
- Access module information
 - DIP switch setting help
 - Module configuration
 - Bluetooth communication

MINI Analog Pro bus and network connection

Digitalizing analog signals: plug-in MINI Analog Pro communication gateways

The plug-in MINI Analog Pro gateways combine the advantages of safe electrical isolation with the benefits of digital communication. With an overall width of less than 50 mm, they can transmit, free of interference, up to eight field signals to industrial bus systems and networks. Save on signal-specific input cards and, at the same time, benefit from consistent electrical isolation right through to the controller, including between the individual channels.

Your advantages

- Space-saving network integration of signal conditioners in any combination
- Safe electrical isolation, including between the individual channels
- Signal-specific I/O input cards are no longer required
- Measure current signals during operation or take readings via NFC in the app
- Quick parameterization via rotary coding switch, software, or app

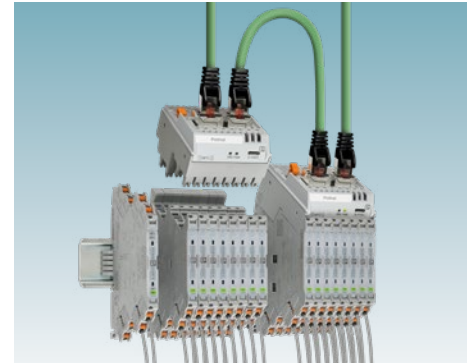

Easy integration into PROFINET networks

Using the MINI Analog Pro PROFINET gateway, various analog and digital signals can be integrated into PROFINET networks. The switch from PROFIBUS to PROFINET protocol is particularly interesting for refitting projects.

The gateway has been certified by the PROFIBUS Nutzerorganisation e.V. user organization in accordance with Conformance Class C and can therefore be easily migrated into a wide range of applications.

The plug-and-play principle also helps in this application. Disconnect the output terminal on the MINI Analog Pro signal conditioners, plug in the PROFINET gateway, connect the network cables – and you're done.

Additional gateways are available for the following protocols: Modbus/TCP, Modbus/RTU, and PROFIBUS

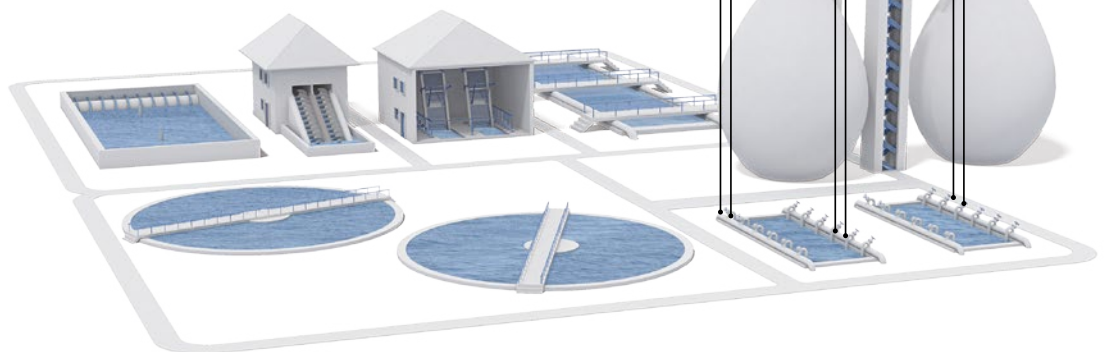
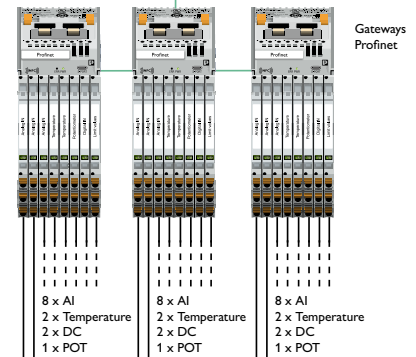





Product overview – MINI Analog Pro bus and network connection

1

2

3

Signal conditioners and measuring transducers

Gateways			
	Description	Item no.	Type
	Eight MINI Analog Pro signal conditioners and measuring transducers are quickly and easily integrated into a Modbus/RTU network via a communication adapter.	2905634	MINI MCR-2-V8-MOD-RTU
	Eight MINI Analog Pro signal conditioners and measuring transducers are quickly and easily integrated into a Modbus/TCP network via a communication adapter.	2905635	MINI MCR-2-V8-MOD-TCP
	Eight MINI Analog Pro signal conditioners and measuring transducers are quickly and easily integrated into a PROFIBUS DP network via a communication adapter.	2905636	MINI MCR-2-V8-PB-DP
	Eight MINI Analog Pro signal conditioners and measuring transducers are quickly and easily integrated into a PROFINET network via a communication adapter.	2905637	MINI MCR-2-V8-PN

Signal conditioners and measuring transducers

MACX Analog signal conditioners and measuring transducers

The MACX Analog signal conditioners and measuring transducers offer you a comprehensive range of solutions for safe and reliable signal conditioning. In intrinsically safe circuits, the Ex i versions provide you with explosion protection in up to all zones and substance groups. The products, developed consistency for safety applications for IEC/EN 61508 and PL EN ISO 13849, ensure the safety of people, the environment, and the system.

COMPLETE line

Push-in Technology[®]

Designed by Phoenix Contact

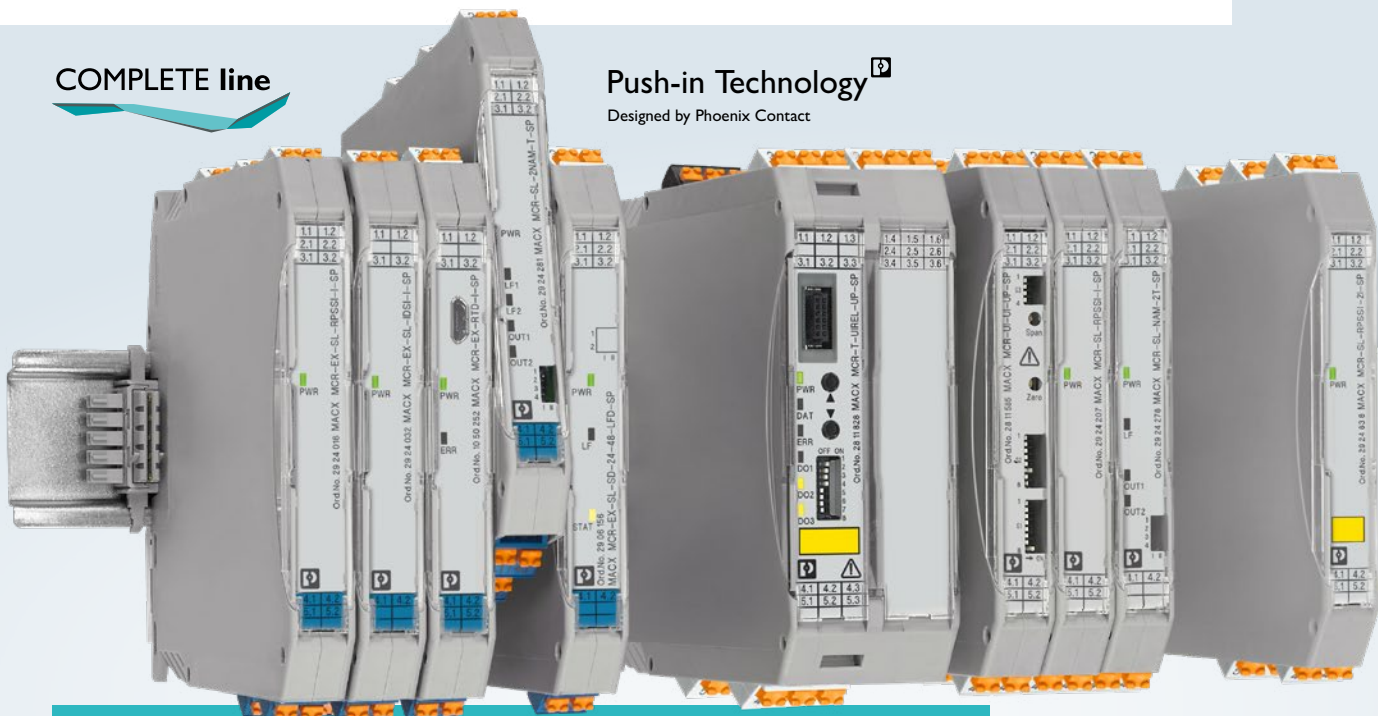

Your advantages

- ✓ Broad international Ex approval package, including mining and marine approvals
- ✓ Reliable and safe in all safety-related applications up to SIL 2 SC 3 or SIL 3
- ✓ Versions with Performance Level certification in accordance with EN ISO 13849
- ✓ Overall width of just 12.5 mm for single- and two-channel products with standard functions
- ✓ Flexible supply: modular 24 V power bridging with group error messaging or wide range input up to 230 V AC/DC



Your advantages in detail



Comprehensive explosion protection for all zones and substance groups

MACX Analog Ex i signal conditioners and measuring transducers have a wide package of international Ex approvals for use in up to all Ex zones and for all substance groups. In addition, mining and marine approvals, as well as versions with an extended temperature operating range of -40 to +70°C and documented requirements for altitude operating ranges up to 5000 m, enable use in demanding environments.



Functional safety for the process industry and machine building

Our MACX Analog Ex signal conditioners and measuring transducers are available for all safety-related applications up to SIL 2 SC 3 or SIL 3. Selected products have PL certification for use in machine building. This applies to both standard applications and explosion protection.

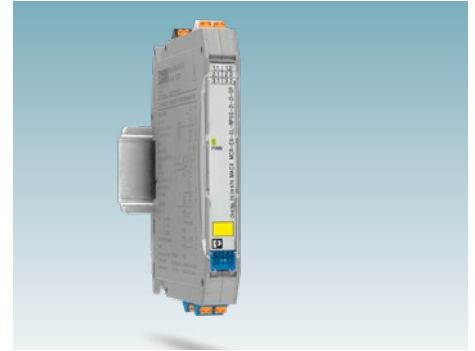

Two-channel design and signal duplication with an overall width of just 12.5 mm

Save space with two-channel versions and signal duplicators with an overall width of just 12.5 mm.

Product overview – MACX Analog for standard applications and explosion protection

Analog IN/OUT

- Universal and standard signal conditioners
- HART-transparent repeater power supplies and output signal conditioners
- Loop-powered signal conditioners

Temperature

- Universal measuring transducers for resistance thermometers, thermocouples, resistance-type sensors, potentiometers, and mV sources, with limit value switching
- Standard temperature transducers for resistance thermometers or thermocouples

Frequency

- Two-channel measuring transducers with NAMUR signal input (IEC/EN 60947-5-6)

Digital IN

- Signal conditioners for NAMUR sensors and floating contacts, with relay, transistor, or NAMUR output (resistive in accordance with EN 6079-5-6)

Digital OUT

- Solenoid drivers with different output characteristics, loop-powered
- Solenoid drivers with 24 V DC supply voltage, different output characteristics and line fault detection

Limit values

- Limit value switches with relay changeover contact output

Accessories

- Partition plate for separating Ex i and non-Ex i signals
- Constant voltage source/constant current source
- Supply components
- Power module with fault monitoring for the power bridging system with the DIN rail connector
- Marking material

Analog IN/OUT

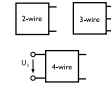

Temperature

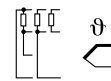

Frequency

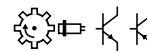

Potentiometer



Digital IN

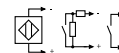

Digital OUT

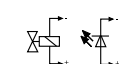

Limit values

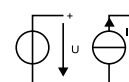

Product overview – MACX Analog for standard applications

Analog IN/OUT								
Product type	Signal conditioner							
Description	3-way signal conditioner, configurable, wide range power supply				3-way signal conditioner, configurable			
Approvals								
Ex installation / Ex i switching circuit	Gc; Div. 2							
Functional safety	SIL 2 / SC 3							
Input signal	Unipolar: 0 mV ... 50 mV to 0 V ... 100 V, 0 mA ... 1 mA to 0 mA ... 100 mA Bipolar: -50 mV ... 50 mV to -100 V ... 100 V, -1 mA ... 1 mA to -100 mA ... 100 mA Life-zero: 1 mA ... 5 mA, 2 mA ... 10 mA, 4 mA ... 20 mA, 1 V ... 5 V, 2 V ... 10 V							
Output signal	Unipolar: 0 mV ... 50 mV to 0 V ... 10 V, 0 mA ... 1 mA to 0 mA ... 20 mA Bipolar: -50 mV ... 50 mV to -10 V ... 10 V, -1 mA ... 1 mA to -20 mA ... 20 mA Life-zero: 1 mA ... 5 mA, 2 mA ... 10 mA, 4 mA ... 20 mA, 1 V ... 5 V, 2 V ... 10 V							
Supply voltage	19.2 V AC/DC ... 253 V AC/DC				9.6 V DC ... 30 V DC			
Ambient temperature range	-20°C ... +70°C							
Fault signaling: LED	No							
Configuration	DIP switch							
Width	12.5 mm							
Delivery state	Standard configuration		Order configuration		Standard configuration		Order configuration	
Type	MACX MCR-UI-UI-UP(-SP)-NC		MACX MCR-UI-UI-UP(-SP)		MACX MCR-UI-UI(-SP)-NC		MACX MCR-UI-UI(-SP)	
Connection method	Push-in connection	Screw connection	Push-in connection	Screw connection	Push-in connection	Screw connection	Push-in connection	Screw connection
Item number	2811569	2811297	2811585	2811459	2811556	2811446	2811572	2811284

The module can be snapped onto the DIN rail connector for 24 V voltage bridging

Wide range input for worldwide supply networks

Product overview – MACX Analog for standard applications

1

2

3

Signal conditioners and measuring transducers

Analog IN								
Product type	Repeater power supply							
Description	Repeater power supply and input signal conditioner, HART-transparent, wide range power supply		Repeater power supply and input signal conditioner, HART-transparent		Repeater power supply and input signal conditioner with two outputs, HART-transparent		Repeater power supply, 2-channel, HART-transparent	
Approvals								
Ex installation / Ex i switching circuit	Gc; Div. 2							
Functional safety	SIL 2 / SC 3				SIL 2 / SC 3 / PL d			
Signal transmission behavior	In = out							
Input signal	0 mA ... 20 mA / 4 mA ... 20 mA						4 mA ... 20 mA	
Output signal	0 mA ... 20 mA / 4 mA ... 20 mA 0 V ... 5 V / 1 V ... 5 V		0 mA ... 20 mA / 4 mA ... 20 mA				4 mA ... 20 mA	
Supply voltage	19.2 V AC/DC ... 253 V AC/DC		19.2 V DC ... 30 V DC					
Ambient temperature range	-40°C ... +70°C							
Fault signaling: LED	No							
Termination Carrier (optional)			2924854 TC-D37SUB-ADIO16-EX-P-UNI / 2902932 TC-D37SUB-AIO16-EX-PS-UNI		2904684 TC-2D37SUB-ADIO32-2EX-P-UNI			
Configuration	DIP switch							
Width	17.5 mm		12.5 mm					
Delivery state	Standard configuration							
Type	MACX MCR-SL-RPSSI-I-UP(-SP)		MACX MCR-SL-RPSSI-I(-SP)		MACX MCR-SL-RPSSI-2I(-SP)		MACX MCR-SL-RPSSI-2I-2I(-SP)	
Connection method	Push-in connection	Screw connection	Push-in connection	Screw connection	Push-in connection	Screw connection	Push-in connection	Screw connection
Item number	2924210	2865968	2924207	2865955	2924838	2924825	2904090	2904089







Important note

The MACX analog product family has been extended with new features. The redesigned items are listed in this brochure. The new version of the items will be launched step by step starting in September 2023.

Please refer to the online shop for the item versions and corresponding technical data that can currently be ordered. You can see which devices have already been revised by the new labeling on the item at phoenixcontact.com.

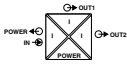
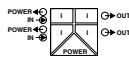

Product overview – MACX Analog for standard applications

Analog IN						
						
Product type	Repeater power supply					
						
Description	Repeater power supply and input signal conditioner, signal duplicator, HART-transparent, 1 output, passive		Repeater power supply and input signal conditioner, signal duplicator, HART-transparent, 2 outputs, passive		Repeater power supply and input signal conditioner, 2-channel, HART-transparent, 2 outputs, passive	
	   					
Ex installation / Ex i switching circuit	Gc; Div. 2					
Functional safety	SIL 2 / SC 3 / PL d			SIL 3 / PL d		
Signal transmission behavior	In = out					
Input signal	0 mA ... 20 mA / 4 mA ... 20 mA			4 mA ... 20 mA		
Output signal	0 mA ... 20 mA / 4 mA ... 20 mA			4 mA ... 20 mA		
Supply voltage	19.2 V DC ... 30 V DC					
Ambient temperature range	-40°C ... +70°C					
Fault signaling: LED	No					
Termination Carrier (optional)	2904684 TC-2D37SUB-ADIO32-2EX-P-UNI					
Width	12.5 mm					
Delivery state	Standard configuration					
Type	MACX MCR-RPSS-I-2I-1P(-SP)		MACX MCR-RPSS-I-2I-2P(-SP)		MACX MCR-RPSS-2I-2I-2P(-SP)	
Connection method	Push-in connection	Screw connection	Push-in connection	Screw connection	Push-in connection	Screw connection
Item number	1430013 new	1430008 new	1430832 new	1430826 new	1487662 new	1487668 new

 The module can be snapped onto the DIN rail connector for 24 V voltage bridging

 Wide range input for worldwide supply networks











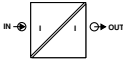
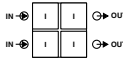

Product overview – MACX Analog for standard applications

1

2

3

Signal conditioners and measuring transducers

Analog IN								
								
Product type	Signal conditioner							
								
Description	Input-loop-powered 2-way isolator, 1-channel		Input-loop-powered 2-way isolator with increased isolating voltage, 1-channel		Input-loop-powered 2-way isolator, 2-channel		Input-loop-powered 2-way isolator with increased isolating voltage, 2-channel	
Approvals								
Ex installation / Ex i switching circuit	Gc; Div. 2							
Functional safety	SIL 3							
Signal transmission behavior	In = out							
Input signal	0 mA ... 20 mA / 4 mA ... 20 mA							
Output signal	0 mA ... 20 mA / 4 mA ... 20 mA							
Supply voltage	Loop-powered, no external supply necessary							
Ambient temperature range	-40°C ... +85°C							
Fault signaling: LED	No							
Width	12.5 mm							
Delivery state	Standard configuration							
Type	MACX MCR-SL-I-I-ILP(-SP)		MACX MCR-SL-I-I-HV-ILP(-SP)		MACX MCR-SL-2I-2I-ILP(-SP)		MACX MCR-SL-2I-2I-HV-ILP(-SP)	
Connection method	Push-in connection	Screw connection	Push-in connection	Screw connection	Push-in connection	Screw connection	Push-in connection	Screw connection
Item number	2905279  new	2905278  new	2907705  new	2907704  new	2905281  new	2905280  new	2907707  new	2907706  new







Important note

The MACX analog product family has been extended with new features. The redesigned items are listed in this brochure. The new version of the items will be launched step by step starting in September 2023.

Please refer to the online shop for the item versions and corresponding technical data that can currently be ordered. You can see which devices have already been revised by the new labeling on the item at phoenixcontact.com.

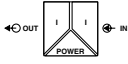
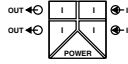

Product overview – MACX Analog for standard applications

Analog OUT			
			
Product type	Output signal conditioner		
			
Description	Output signal conditioner, HART-transparent		Output signal conditioner, 2-channel, HART-transparent
Approvals			
Ex installation / Ex i switching circuit	Gc; Div. 2		
Functional safety	SIL 2 / SC 3		SIL 3
Signal transmission behavior	In = out		
Input signal	0 mA ... 20 mA / 0,2 mA ... 20 mA / 4 mA ... 20 mA		0.2 mA ... 20 mA / 4 mA ... 20 mA
Output signal	0 mA ... 20 mA / 0,2 mA ... 20 mA / 4 mA ... 20 mA		0.2 mA ... 20 mA / 4 mA ... 20 mA
Supply voltage	19.2 V DC ... 30 V DC		
Ambient temperature range	-40°C ... +70°C		
Fault signaling: LED	No		
Termination Carrier (optional)	2924854 TC-D37SUB-ADIO16-EX-P-UNI / 2902932 TC-D37SUB-AIO16-EX-PS-UNI		2904684 TC-2D37SUB-ADIO32-2EX-P-UNI
Configuration	DIP switch		
Width	12.5 mm		
Delivery state	Standard configuration		
Type	MACX MCR-IDS-I-I(-SP)		MACX MCR-IDS-2I-2I(-SP)
Connection method	Push-in connection	Screw connection	Push-in connection Screw connection
Item number	2908064  new	2908063  new	2908066  new

 The module can be snapped onto the DIN rail connector for 24 V voltage bridging

 Wide range input for worldwide supply networks











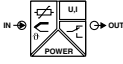
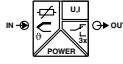

Product overview – MACX Analog for standard applications

1

2

3

Signal conditioners and measuring transducers

Temperature								
								
Product type	Temperature transducer							
								
Description	Universal temperature transducer, with limit value relay, wide range power supply, configurable			Universal temperature transducer, with three limit relays, wide range power supply, configurable				
Approvals								
Ex installation / Ex i switching circuit	Gc; Div. 2							
Functional safety	SIL 2 / PL d							
Usable input source	RTD: Pt, Ni, Cu sensors / 2, 3, 4-conductor / TC: B, E, J, K, N, R, S, T, L, U, CA, DA, A1G, A2G, A3G, MG, LG							
Input signal	-250°C ... 2500°C (range depending on the sensor type) / linear resistance: 0 Ω ... 50 kΩ / potentiometer: 0 Ω ... 50 kΩ / -1000 mV ... 1000 mV							
Output signal	0 mA ... 20 mA / 4 mA ... 20 mA							
Switching output	Relay output (1 changeover contact)			Relay output (3 changeover contacts)				
Supply voltage	19.2 V AC/DC ... 253 V AC/DC							
Ambient temperature range	-20°C ... +65°C							
Fault signaling: LED	Yes							
Fault monitoring	Wire break / short circuit / over-range / under-range / device error							
Configuration	DIP switch / software							
Width	17.5 mm			35 mm				
Delivery state	Standard configuration		Order configuration		Standard configuration		Order configuration	
Type	MACX MCR-T-UI-UP(-SP)		MACX MCR-T-UI-UP(-SP)-C		MACX MCR-T-UIREL-UP(-SP)		MACX MCR-T-UIREL-UP(-SP)-C	
Connection method	Push-in connection	Screw connection	Push-in connection	Screw connection	Push-in connection	Screw connection	Push-in connection	Screw connection
Item number	2811860  new	2811394  new	2811970  new	2811873  new	2811828  new	2811378  new	2811831  new	2811514  new

Important note

The MACX analog product family has been extended with new features. The redesigned items are listed in this brochure. The new version of the items will be launched step by step starting in September 2023.

Please refer to the online shop for the item versions and corresponding technical data that can currently be ordered. You can see which devices have already been revised by the new labeling on the item at phoenixcontact.com.









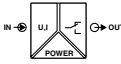

Product overview – MACX Analog for standard applications

Temperature					
Product type	Temperature transducer				
Description	Temperature transducer for RTD sensors, configurable		Temperature transducer for TC sensors, configurable		
Approvals					
Ex installation / Ex i switching circuit	Gc; Div. 2				
Functional safety	SIL 2				
Usable input source	RTD: Pt, Ni, Cu sensors: 2, 3, 4-conductor		TC: B, E, J, K, N, R, S, T, L, U, C, D, A-1, A-2, A-3, M, Lr		
Input signal	-200°C ... 850°C (range depending on the sensor type) / linear resistance: 0 Ω ... 50 kΩ / potentiometer: 0 Ω ... 50 kΩ		-250°C ... 2500°C (range depending on the sensor type) / -1000 mV ... 1000 mV		
Output signal	0 mA ... 20 mA / 4 mA ... 20 mA				
Supply voltage	19.2 V DC ... 30 V DC				
Ambient temperature range	-40°C ... +70°C				
Fault signaling: LED	Yes				
Fault monitoring	Wire break / short circuit / over-range / under-range / device error		Wire break / over-range / under-range / device error		
Configuration	Software				
Width	12.5 mm				
Delivery state	Standard configuration		Order configuration		Standard configuration
					Order configuration
Type	MACX MCR-RTD-I(-SP)		MACX MCR-RTD-I(-SP)-C		MACX MCR-TC-I
					MACX MCR-TC-I-C
Connection method	Push-in connection	Screw connection	Push-in connection	Screw connection	
Item number	1050201 new	1050192 new	1052464 new	1052472 new	1050228 new
					1052459 new

The module can be snapped onto the DIN rail connector for 24 V voltage bridging

Wide range input for worldwide supply networks

Product overview – MACX Analog for standard applications

Limit values			
			
Product type	Limit value switch		
			
Description	Limit value switch, configurable		
			
Approvals			
Ex installation / Ex i switching circuit	Gc; Div. 2		
Functional safety	SIL 2 / SC 3 / PL c		
Input signal	0.2 mA ... 20 mA 0.1 V ... 10 V		
Switching output	Relay output (1 changeover contact)		
Supply voltage	9.6 V DC ... 30 V DC		
Ambient temperature range	-20°C ... +65°C		
Fault signaling: LED	Yes		
Fault monitoring	Wire break / short circuit / device error		
Configuration	DIP switch		
Width	12.5 mm		
Delivery state	Standard configuration		
Type	MACX MCR-SL-UI-REL(-SP)		
Connection method	<table border="0" style="width: 100%;"> <tr> <td style="width: 50%; text-align: center;">Push-in connection</td> <td style="width: 50%; text-align: center;">Screw connection</td> </tr> </table>	Push-in connection	Screw connection
Push-in connection	Screw connection		
Item number	<table border="0" style="width: 100%;"> <tr> <td style="width: 50%; text-align: center;"> 2906170  new </td> <td style="width: 50%; text-align: center;"> 2906169  new </td> </tr> </table>	2906170  new	2906169  new
2906170  new	2906169  new		

Important note

The MACX analog product family has been extended with new features. The redesigned items are listed in this brochure. The new version of the items will be launched step by step starting in September 2023.

Please refer to the online shop for the item versions and corresponding technical data that can currently be ordered. You can see which devices have already been revised by the new labeling on the item at phoenixcontact.com.



Product overview – MACX Analog for standard applications

Digital IN									
Product type	Signal conditioner								
Description	NAMUR signal conditioner				NAMUR signal conditioner, 2-channel				
Approvals									
Ex installation / Ex i switching circuit	Gc; Div. 2								
Functional safety	SIL 2 / SC 3								
Usable input source	NAMUR proximity sensors (IEC/EN 60947-5-6) / floating switch contacts / switching contacts with resistance circuits								
Switching output	Relay output (1 changeover contact)		Relay output (2 N/O contacts)		Relay output (1 N/O contact per channel)		Relay output (1 changeover contact per channel)		
Supply voltage	19.2 V DC ... 30 V DC						19.2 V AC/DC ... 253 V AC/DC		
Ambient temperature range	-40°C ... +70°C								
Fault signaling: LED	Yes								
Fault monitoring	Wire break / short circuit / device error								
Termination Carrier (optional)	2924854 TC-D37SUB-ADIO16-EX-P-UNI		2904684 TC-2D37SUB-ADIO32-2EX-P-UNI						
Configuration	DIP switch								
Width	12.5 mm						17.5 mm		
Delivery state	Standard configuration								
Type	MACX MCR-SL-NAM-R(-SP)		MACX MCR-SL-NAM-2RO(-SP)		MACX MCR-SL-2NAM-RO(-SP)		MACX MCR-SL-2NAM-R-UP(-SP)		
Connection method	Push-in connection	Screw connection	Push-in connection	Screw connection	Push-in connection	Screw connection	Push-in connection	Screw connection	
Item number	2924252	2865997	2924265	2865010	2924294	2865049	2924304	2865052	
	new	new	new	new	new	new	new	new	

The module can be snapped onto the DIN rail connector for 24 V voltage bridging

Wide range input for worldwide supply networks









Product overview – MACX Analog for standard applications

1

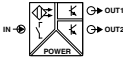
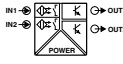
2

3

Signal conditioners and measuring transducers

Digital IN			
			
Product type	Signal conditioner		
			
Description	NAMUR signal conditioner		NAMUR signal conditioner, 2-channel
Approvals			
Ex installation / Ex i switching circuit	Gc; Div. 2		
Functional safety	SIL 2 / SC 3		
Usable input source	NAMUR proximity sensors (IEC/EN 60947-5-6) / floating switch contacts / switching contacts with resistance circuits		
Output signal	2 transistor outputs, passive Switching voltage: ≤30 V DC Switching current: ≤50 mA Switching frequency: ≤5 kHz Signal output 2 can also be configured as an error message output		1 transistor output per channel, passive Switching voltage: ≤30 V DC Switching current: ≤50 mA Switching frequency: ≤5 kHz
Switching output	Transistor output (passive)		
Supply voltage	19.2 V DC ... 30 V DC		
Ambient temperature range	-40°C ... +70°C		
Fault signaling: LED	Yes		
Fault monitoring	Wire break / short circuit / device error		
Termination Carrier (optional)	2904684 TC-2D37SUB-ADIO32-2EX-P-UNI		
Configuration	DIP switch		
Width	12.5 mm		
Delivery state	Standard configuration		
Type	MACX MCR-SL-NAM-2T(-SP)		MACX MCR-SL-2NAM-T(-SP)
Connection method	Push-in connection	Screw connection	Push-in connection Screw connection
Item number	2924278  new	2865023  new	2924281  new 2865036  new

Important note

The MACX analog product family has been extended with new features. The redesigned items are listed in this brochure. The new version of the items will be launched step by step starting in September 2023.

Please refer to the online shop for the item versions and corresponding technical data that can currently be ordered. You can see which devices have already been revised by the new labeling on the item at phoenixcontact.com.



Product overview – MACX Analog for explosion protection

Analog IN								
Product type	Repeater power supply							
Description	Ex i repeater power supply and input signal conditioner, HART-transparent, wide range power supply		Ex i repeater power supply and input signal conditioner, HART-transparent		Ex i repeater power supply and input signal conditioner with two outputs, HART-transparent		Ex i repeater power supply and input signal conditioner with two outputs, only one channel HART-transparent	
Approvals								
Approvals								
Ex installation / Ex i switching circuit	Gc; Div. 2 / Ga; Da; Ma; Div. 1							
Functional safety	SIL 2 / SC 3				SIL 2 / SC 3 / PL d			
Signal transmission behavior	In = out							
Input signal	0 mA ... 20 mA / 4 mA ... 20 mA							
Output signal	0 mA ... 20 mA / 4 mA ... 20 mA / 0 V ... 5 V / 1 V ... 5 V		0 mA ... 20 mA / 4 mA ... 20 mA					
Supply voltage	19.2 V AC/DC ... 253 V AC/DC		19.2 V DC ... 30 V DC					
Ambient temperature range	-40°C ... +70°C							
Fault signaling: LED	No							
Termination Carrier (optional)			2924854 TC-D37SUB-ADIO16-EX-P-UNI / 2902932 TC-D37SUB-AIO16-EX-PS-UNI		2904684 TC-2D37SUB-ADIO32-2EX-P-UNI			
Configuration	DIP switch							
Width	17.5 mm		12.5 mm					
Delivery state	Standard configuration							
Type	MACX MCR-EX-SL-RPSSI-I-UP(-SP)		MACX MCR-EX-SL-RPSSI-I(-SP)		MACX MCR-EX-SL-RPSSI-2I(-SP)		MACX MCR-EX-SL-RPSSI-2I-1S(-SP)	
Connection method	Push-in connection	Screw connection	Push-in connection	Screw connection	Push-in connection	Screw connection	Push-in connection	Screw connection
Item number	2924029	2865793	2924016	2865340	2924236	2865366	2908856	2908855
	new	new	new	new	new	new	new	new

The module can be snapped onto the DIN rail connector for 24 V voltage bridging

Wide range input for worldwide supply networks

Product overview – MACX Analog for explosion protection

1

2

3

Signal conditioners and measuring transducers

Analog IN								
Product type	Repeater power supply							
Description	Ex i repeater power supply, 2-channel, HART-transparent		Ex i repeater power supply and input signal conditioner, signal duplicator, HART-transparent, 1 output, passive		Ex i repeater power supply and input signal conditioner, signal duplicator, HART-transparent, 2 outputs, passive		Ex i repeater power supply, 2-channel, HART-transparent, 2 outputs, passive	
Approvals								
Ex installation / Ex i switching circuit	Gc; Div. 2 / Ga; Da; Ma; Div. 1							
Functional safety	SIL 3 / PL d		SIL 2 / SC 3 / PL d				SIL 3 / PL d	
Signal transmission behavior	In = out							
Input signal	4 mA ... 20 mA		0 mA ... 20 mA / 4 mA ... 20 mA				4 mA ... 20 mA	
Output signal	4 mA ... 20 mA		0 mA ... 20 mA / 4 mA ... 20 mA				4 mA ... 20 mA	
Supply voltage	19.2 V DC ... 30 V DC							
Ambient temperature range	-40°C ... +70°C							
Fault signaling: LED	No							
Termination Carrier (optional)	2904684 TC-2D37SUB-ADIO32-2EX-P-UNI							
Width	12.5 mm							
Delivery state	Standard configuration							
Type	MACX MCR-EX-SL-RPSS-2I-2I(-SP)		MACX MCR-EX-RPSS-I-2I-1P(-SP)		MACX MCR-EX-RPSS-I-2I-2P(-SP)		MACX MCR-EX-RPSS-2I-2I-2P(-SP)	
Connection method	Push-in connection	Screw connection	Push-in connection	Screw connection	Push-in connection	Screw connection	Push-in connection	Screw connection
Item number	2924676	2865382	1429992	1429610	1430112	1430001	1497171	1497179

Important note

The MACX analog product family has been extended with new features. The redesigned items are listed in this brochure. The new version of the items will be launched step by step starting in September 2023.

Please refer to the online shop for the item versions and corresponding technical data that can currently be ordered. You can see which devices have already been revised by the new labeling on the item at phoenixcontact.com.



Product overview – MACX Analog for explosion protection

Analog IN			
Product type	Repeater power supply		
Description	Ex i repeater power supply and input signal conditioner, HART-transparent, limit value outputs		Ex i repeater power supply and input signal conditioner, HART-transparent, also for 3-conductor sensors
Ex installation / Ex i switching circuit	Gc / Ga; Da; Ma		
Functional safety	SIL 2		SIL 3
Signal transmission behavior	In = out		
Input signal	4 mA ... 20 mA		0 mA ... 20 mA / 4 mA ... 20 mA
Output signal	4 mA ... 20 mA		0 mA ... 20 mA / 4 mA ... 20 mA
Switching output	Relay output (2 N/O contacts)		
Supply voltage	18 V ... 31.2 V		
Ambient temperature range	-40°C ... +70°C		-20°C ... +70°C
Fault signaling: LED	Yes		
Width	17.5 mm		
Delivery state	Standard configuration		
Type	MACX MCR-EX-AP-RPSS-I-IR(-SP)		MACX MCR-EX-AP-RPSS-I-I(-SP)
Connection method	Push-in connection	Screw connection	Push-in connection Screw connection
Item number	1290776 new	1290774 new	1291193 new 1291191 new

The module can be snapped onto the DIN rail connector for 24 V voltage bridging

Wide range input for worldwide supply networks

Product overview – MACX Analog for explosion protection

Analog OUT						
Product type	Output signal conditioner					
Description	Ex i output signal conditioner, HART-transparent		Ex i output signal conditioner, 2-channel, HART-transparent		Ex i output signal conditioner, 2-channel, HART-transparent, input loop powered	
Approvals						
Ex installation / Ex i switching circuit	Gc; Div. 2 / Ga; Da; Ma; Div. 1				Gc / Ga; Da; Ma	
Functional safety	SIL 2 / SC 3		SIL 3			
Signal transmission behavior	In = out					
Input signal	0 mA ... 20 mA / 0,2 mA ... 20 mA / 4 mA ... 20 mA		0,2 mA ... 20 mA / 4 mA ... 20 mA		0 mA ... 20 mA / 4 mA ... 20 mA	
Output signal	0 mA ... 20 mA / 0,2 mA ... 20 mA / 4 mA ... 20 mA		0,2 mA ... 20 mA / 4 mA ... 20 mA		0 mA ... 20 mA / 4 mA ... 20 mA	
Supply voltage	19.2 V DC ... 30 V DC				Loop-powered, no external supply necessary	
Ambient temperature range	-40°C ... +70°C				-20°C ... +70°C	
Fault signaling: LED	No					
Termination Carrier (optional)	2924854 TC-D37SUB-ADIO16-EX-P-UNI / 2902932 TC-D37SUB-AIO16-EX-PS-UNI		2904684 TC-2D37SUB-ADIO32-2EX-P-UNI			
Configuration	DIP switch					
Width	12.5 mm				17.5 mm	
Delivery state	Standard configuration					
Type	MACX MCR-EX-IDS-I-I(-SP)		MACX MCR-EX-IDS-2I-2I(-SP)		MACX MCR-EX-AP-IDS-2I-2I-LP(-SP)	
Connection method	Push-in connection	Screw connection	Push-in connection	Screw connection	Push-in connection	Screw connection
Item number	2908062 new	2908060 new	2904931 new	2865421 new	1291983 new	1291963 new

Important note

The MACX analog product family has been extended with new features. The redesigned items are listed in this brochure. The new version of the items will be launched step by step starting in September 2023.

Please refer to the online shop for the item versions and corresponding technical data that can currently be ordered. You can see which devices have already been revised by the new labeling on the item at phoenixcontact.com.



Product overview – MACX Analog for explosion protection

Temperature								
Product type	Temperature transducer							
Description	Universal Ex i temperature transducer, with limit value relay, wide range power supply, configurable				Universal temperature transducer, with three limit relays, wide range power supply, configurable			
Approvals								
Ex installation / Ex i switching circuit	Gc; Div. 2 / Ga; Da; Ma; Div. 1							
Functional safety	SIL 2 / PL d							
Usable input source	RTD: Pt, Ni, Cu sensors / 2, 3, 4-conductor / TC: B, E, J, K, N, R, S, T, L, U, CA, DA, A1G, A2G, A3G, MG, LG							
Input signal	-250°C ... 2500°C (range depending on the sensor type) / linear resistance: 0 Ω ... 50 kΩ / potentiometer: 0 Ω ... 50 kΩ / -1000 mV ... 1000 mV							
Output signal	0 mA ... 20 mA / 4 mA ... 20 mA							
Switching output	Relay output (1 changeover contact)				Relay output (3 changeover contacts)			
Supply voltage	19.2 V AC/DC ... 253 V AC/DC							
Ambient temperature range	-20°C ... +65°C							
Fault signaling: LED	Yes							
Fault monitoring	Wire break / short circuit / over-range / under-range / device error							
Configuration	DIP switch / software							
Width	17.5 mm				35 mm			
Delivery state	Standard configuration		Order configuration		Standard configuration		Order configuration	
Type	MACX MCR-EX-T-UI-UP(-SP)		MACX MCR-EX-T-UI-UP(-SP)-C		MACX MCR-EX-T-UIREL-UP(-SP)		MACX MCR-EX-T-UIREL-UP(-SP)-C	
Connection method	Push-in connection	Screw connection	Push-in connection	Screw connection	Push-in connection	Screw connection	Push-in connection	Screw connection
Item number	2924689	2865654	2924692	2811763	2924799	2865751	2924809	2865722

The module can be snapped onto the DIN rail connector for 24 V voltage bridging

Wide range input for worldwide supply networks













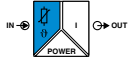



Product overview – MACX Analog for explosion protection

1

2

3

Signal conditioners and measuring transducers

Temperature						
						
Product type	Temperature transducer					
						
Description	Ex i temperature transducer for RTD sensors, configurable			Ex i temperature transducer for TC sensors, configurable		
						
Approvals						
Ex installation / Ex i switching circuit	Gc; Div. 2 / Ga; Da; Ma; Div. 1					
Functional safety	SIL 2					
Usable input source	RTD: Pt, Ni, Cu sensors: 2, 3, 4-conductor			TC: B, E, J, K, N, R, S, T, L, U, C, D, A-1, A-2, A-3, M, Lr		
Input signal	-200°C ... 850°C (range depending on the sensor type) / linear resistance: 0 Ω ... 50 kΩ / potentiometer: 0 Ω ... 50 kΩ			-250°C ... 2500°C (range depending on the sensor type) / -1000 mV ... 1000 mV		
Output signal	0 mA ... 20 mA / 4 mA ... 20 mA					
Supply voltage	19.2 V DC ... 30 V DC					
Ambient temperature range	-40°C ... +70°C					
Fault signaling: LED	Yes					
Fault monitoring	Wire break / short circuit / over-range / under-range / device error			Wire break / over-range / under-range / device error		
Configuration	Software					
Width	12.5 mm					
Delivery state	Standard configuration		Order configuration		Standard configuration	
Type	MACX MCR-EX-RTD-I(-SP)		MACX MCR-EX-RTD-I(-SP)-C		MACX MCR-EX-TC-I	
Connection method	Push-in connection	Screw connection	Push-in connection	Screw connection		
Item number	1050252  new	1050222  new	1052652  new	1052463  new	1050233  new	1052458  new





Important note

The MACX analog product family has been extended with new features. The redesigned items are listed in this brochure. The new version of the items will be launched step by step starting in September 2023.

Please refer to the online shop for the item versions and corresponding technical data that can currently be ordered. You can see which devices have already been revised by the new labeling on the item at phoenixcontact.com.

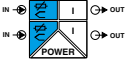

Product overview – MACX Analog for explosion protection

Temperature				
				
Product type	Temperature transducer			
				
Description	Universal Ex i temperature transducer, 2-channel		Ex i resistance isolator	
				
Ex installation / Ex i switching circuit	Gc / Ga; Da; Ma			
Signal transmission behavior	In = out			
Usable input source	RTD: Pt 100, Pt 250, Pt 500, Pt 1000, Pt 2000, Ni 100, Ni 500, Ni 1000, M50, M53, M100 / TC: B, E, J, K, N, R, S, T, L, U, XK / 2-, 3-, 4-conductor		RTD: Pt 100 / 2-, 3-, 4-conductor	
Input signal	-200°C ... 1800°C (range depending on the sensor type)		Linear resistance: 18 Ω ... 391 Ω (Pt 100)	
Output signal	0 mA ... 20 mA / 4 mA ... 20 mA		Linear resistance: 18 Ω ... 391 Ω (Pt 100)	
Supply voltage	18 V ... 31.2 V			
Ambient temperature range	-20°C ... +70°C			
Fault signaling: LED	Yes			
Configuration	Software			
Width	17.5 mm			
Delivery state	Standard configuration			
Type	MACX MCR-EX-AP-2T-2(-SP)		MACX MCR-EX-AP-RTD-RTD(-SP)	
Connection method	Push-in connection	Screw connection	Push-in connection	Screw connection
Item number	1290849 new	1290780 new	1291955 new	1291894 new

 The module can be snapped onto the DIN rail connector for 24 V voltage bridging

 Wide range input for worldwide supply networks



Product overview – MACX Analog for explosion protection

1

2

3

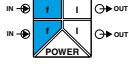
Signal conditioners and measuring transducers

Frequency	
	
Product type	Frequency transducer
	
Description	Ex i frequency transducer, 2-channel
	
Ex installation / Ex i switching circuit	Gc / Ga; Da; Ma
Usable input source	In accordance with IEC/EN 60947-5-6 NAMUR
Input signal	0.001 Hz ... 20000 Hz
Output signal	0 mA ... 20 mA / 4 mA ... 20 mA
Supply voltage	18 V ... 31.2 V
Ambient temperature range	-40°C ... +70°C
Fault signaling: LED	Yes
Configuration	Software
Width	17.5 mm
Delivery state	Standard configuration
Type	MACX MCR-EX-AP-2F-2I(-SP)
Connection method	<div style="display: flex; justify-content: space-around;"> Push-in connection Screw connection </div>
Item number	<div style="display: flex; justify-content: space-around;"> <div style="text-align: center;"> 1290533 new </div> <div style="text-align: center;"> 1290530 new </div> </div>

Product overview – MACX Analog for explosion protection

1

2

3

Signal conditioners and measuring transducers

Digital IN								
Product type	Signal conditioner							
Description	Ex i NAMUR signal conditioner			Ex i NAMUR signal conditioner, 2-channel				
Approvals								
Ex installation / Ex i switching circuit	Gc; Div. 2 / Ga; Da; Ma; Div. 1							
Functional safety	SIL 2 / SC 3							
Usable input source	NAMUR proximity sensors (IEC/EN 60947-5-6) / floating switch contacts / switching contacts with resistance circuits							
Switching output	Relay output (1 changeover contact)		Relay output (2 N/O contacts)		Relay output (1 N/O contact per channel)		Relay output (1 changeover contact per channel)	
Supply voltage	19.2 V DC ... 30 V DC						19.2 V AC/DC ... 253 V AC/DC	
Ambient temperature range	-40°C ... +70°C							
Fault signaling: LED	Yes							
Fault monitoring	Wire break / short circuit / device error							
Termination Carrier (optional)	2924854 TC-D37SUB-ADIO16-EX-P-UNI		2904684 TC-2D37SUB-ADIO32-2EX-P-UNI					
Configuration	DIP switch							
Width	12.5 mm						17.5 mm	
Delivery state	Standard configuration							
Type	MACX MCR-EX-SL-NAM-R(-SP)		MACX MCR-EX-SL-NAM-2RO(-SP)		MACX MCR-EX-SL-2NAM-RO(-SP)		MACX MCR-EX-SL-2NAM-R-UP(-SP)	
Connection method	Push-in connection	Screw connection	Push-in connection	Screw connection	Push-in connection	Screw connection	Push-in connection	Screw connection
Item number	2924045	2865434	2924061	2865450	2924087	2865476	2924249	2865984
	new		new		new		new	

Important note

The MACX analog product family has been extended with new features. The redesigned items are listed in this brochure. The new version of the items will be launched step by step starting in September 2023.

Please refer to the online shop for the item versions and corresponding technical data that can currently be ordered. You can see which devices have already been revised by the new labeling on the item at phoenixcontact.com.



Product overview – MACX Analog for explosion protection

Digital IN						
Product type	Signal conditioner					
Description	Ex i NAMUR signal conditioner		Ex i NAMUR signal conditioner, 2-channel		Ex i NAMUR signal conditioner, output with resistive behavior, with line fault transparency	
Approvals						
Ex installation / Ex i switching circuit	Gc; Div. 2 / Ga; Da; Ma; Div. 1					
Functional safety	SIL 2 / SC 3					
Usable input source	NAMUR proximity sensors (IEC/EN 60947-5-6) / floating switch contacts / switching contacts with resistance circuits					
Switching output	Transistor output (passive)					
Supply voltage	19.2 V DC ... 30 V DC			9.6 V DC ... 30 V DC		
Ambient temperature range	-40°C ... +70°C					
Fault signaling: LED	Yes					
Fault monitoring	Wire break / short circuit / device error					
Termination Carrier (optional)	2904684 TC-2D37SUB-ADIO32-2EX-P-UNI				2924854 TC-D37SUB-ADIO16-EX-P-UNI	
Configuration	DIP switch					
Width	12.5 mm					
Delivery state	Standard configuration					
Type	MACX MCR-EX-SL-NAM-2T(-SP)		MACX MCR-EX-SL-2NAM-T(-SP)		MACX MCR-EX-SL-NAM-NAM(-SP)	
Connection method	Push-in connection	Screw connection	Push-in connection	Screw connection	Push-in connection	Screw connection
Item number	2924074 new	2865463 new	2924090 new	2865489 new	2924883 new	2866006 new

The module can be snapped onto the DIN rail connector for 24 V voltage bridging

Wide range input for worldwide supply networks



Product overview – MACX Analog for explosion protection

1

2

3

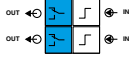
Signal conditioners and measuring transducers

Digital IN			
			
Product type	Relay module		
			
Description	Ex i relay module, 2-channel		
			
Ex installation / Ex i switching circuit	Gc / Ga; Da; Ma		
Functional safety	SIL 2		
Input signal	12 V ... 31.2 V (switching signal)		
Switching output	Relay output (1 changeover contact per channel)		
Supply voltage	Loop-powered, no external supply necessary		
Ambient temperature range	-20°C ... +70°C		
Fault signaling: LED	No		
Width	17.5 mm		
Delivery state	Standard configuration		
Type	MACX MCR-EX-AP-2REL-2DI-LP(-SP)		
Connection method	<table border="0" style="width: 100%;"> <tr> <td style="text-align: center;">Push-in connection</td> <td style="text-align: center;">Screw connection</td> </tr> </table>	Push-in connection	Screw connection
Push-in connection	Screw connection		
Item number	<table border="0" style="width: 100%;"> <tr> <td style="text-align: center;"> 1292332 <div style="background-color: #e91e63; color: white; padding: 2px; display: inline-block;">new</div> </td> <td style="text-align: center;"> 1292331 <div style="background-color: #e91e63; color: white; padding: 2px; display: inline-block;">new</div> </td> </tr> </table>	1292332 <div style="background-color: #e91e63; color: white; padding: 2px; display: inline-block;">new</div>	1292331 <div style="background-color: #e91e63; color: white; padding: 2px; display: inline-block;">new</div>
1292332 <div style="background-color: #e91e63; color: white; padding: 2px; display: inline-block;">new</div>	1292331 <div style="background-color: #e91e63; color: white; padding: 2px; display: inline-block;">new</div>		





Important note

The MACX analog product family has been extended with new features. The redesigned items are listed in this brochure. The new version of the items will be launched step by step starting in September 2023.

Please refer to the online shop for the item versions and corresponding technical data that can currently be ordered. You can see which devices have already been revised by the new labeling on the item at [phoenixcontact.com](https://www.phoenixcontact.com).

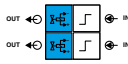

Product overview – MACX Analog for explosion protection

Digital OUT								
								
Product type	Solenoid driver							
								
Description	Solenoid driver, with logic input and line fault detection, current limitation at 25 mA		Solenoid driver, with logic input and line fault detection, current limitation at 48 mA		Solenoid driver, 2-channel, loop-powered, current limitation at 35 mA			
Approvals								
Ex installation / Ex i switching circuit	Gc; Div. 2 / Ga; Da; Ma; Div. 1				Gc / Ga; Da; Ma			
Functional safety	SIL 3							
Input signal	Switching level "0" signal: 0 V DC ... 5 V DC (or open) / Switching level "1" signal: 15 V DC ... 30 V DC				Switching level "0" signal: 0 V ... 5 V / Switching level "1" signal: 18 V ... 31.2 V			
Output signal	Output voltage: ≥ 4.64 V DC (25.1 mA) / no-load voltage: > 21.1 V DC / current limitation: > 25.1 mA (with line fault detection) / output resistance: $\geq 641 \Omega$ (internal resistance Ri)		Output voltage: ≥ 9.7 V DC (48 mA) / no-load voltage: > 24.3 V DC / current limitation: > 48 mA (with line fault detection) / output resistance: $\geq 297 \Omega$ (internal resistance Ri)		Output voltage: ≥ 9.36 V DC (48 mA) / no-load voltage: > 22.5 V DC / current limitation: > 48 mA (with line fault detection) / output resistance: $\geq 269.3 \Omega$ (internal resistance Ri)		No-load voltage: 25 V DC / current limitation: 35 mA / output resistance: 250 Ω (internal resistance Ri)	
Supply voltage	19.2 V DC ... 30 V DC				Loop-powered, no external supply necessary			
Ambient temperature range	-20°C ... +70°C							
Fault signaling: LED	Yes				No			
Fault monitoring	Wire break / short circuit / device error							
Termination Carrier (optional)	2924854 TC-D37SUB-ADIO16-EX-P-UNI							
Configuration	DIP switch							
Width	12.5 mm				17.5 mm			
Delivery state	Standard configuration							
Type	MACX MCR-EX-SL-SD-21-25-LFD(-SP)		MACX MCR-EX-SL-SD-24-48-LFD(-SP)		MACX MCR-EX-SL-SD-23-48-LFD(-SP)		MACX MCR-EX-AP-2SD-25-35-LP(-SP)	
Connection method	Push-in connection	Screw connection	Push-in connection	Screw connection	Push-in connection	Screw connection	Push-in connection	Screw connection
Item number	2905674 ! new	2905669 ! new	2906156 ! new	2906155 ! new	2924870 ! new	2924867 ! new	1291186 ! new	1291176 ! new

 The module can be snapped onto the DIN rail connector for 24 V voltage bridging

 Wide range input for worldwide supply networks









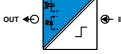

Product overview – MACX Analog for explosion protection

1

2

3

Signal conditioners and measuring transducers

Digital OUT								
								
Product type	Solenoid driver							
								
Description	Solenoid driver, loop-powered, current limitation at 25 mA		Solenoid driver, loop-powered, current limitation at 40 mA		Solenoid driver, loop-powered, current limitation at 48 mA		Solenoid driver, loop-powered, current limitation at 58 mA	
Approvals								
Ex installation / Ex i switching circuit	Gc; Div. 2 / Ga; Da; Ma; Div. 1							
Functional safety	SIL 3							
Input signal	19.2 V DC ... 30 V DC / 45 mA (U _e = 24 V DC)		19.2 V DC ... 30 V DC / 65 mA (U _e = 24 V DC)		19.2 V DC ... 30 V DC / 85 mA (U _e = 24 V DC)		19.2 V DC ... 30 V DC / 95 mA (U _e = 24 V DC)	
Output signal	Output voltage: ≥5.5 V DC (25 mA) / no-load voltage: >21.9 V DC / current limitation: >25 mA / output resistance: ≥641.1 Ω (internal resistance R _i)		Output voltage: ≥10 V DC (40 mA) / no-load voltage: >21.9 V DC / current limitation: >40 mA / output resistance: ≥287 Ω (internal resistance R _i)		Output voltage: ≥10.5 V DC (48 mA) / no-load voltage: >24 V DC / current limitation: >48 mA / output resistance: ≥275.7 Ω (internal resistance R _i)		Output voltage: ≥12.9 V DC (58 mA) / no-load voltage: >21.9 V DC / current limitation: >58 mA / output resistance: ≥133.4 Ω (internal resistance R _i)	
Supply voltage	Loop-powered, no external supply necessary							
Ambient temperature range	-40°C ... +70°C							
Fault signaling: LED	No							
Termination Carrier (optional)	2924854 TC-D37SUB-ADIO16-EX-P-UNI							
Width	12.5 mm							
Delivery state	Standard configuration							
Type	MACX MCR-EX-SL-SD-21-25-LP(-SP)		MACX MCR-EX-SL-SD-21-40-LP(-SP)		MACX MCR-EX-SL-SD-24-48-LP(-SP)		MACX MCR-EX-SL-SD-21-60-LP(-SP)	
Connection method	Push-in connection	Screw connection	Push-in connection	Screw connection	Push-in connection	Screw connection	Push-in connection	Screw connection
Item number	2924113  new	2865492  new	2924139  new	2865764  new	2924126  new	2865609  new	2924100  new	2865515  new

Important note

The MACX analog product family has been extended with new features. The redesigned items are listed in this brochure. The new version of the items will be launched step by step starting in September 2023.

Please refer to the online shop for the item versions and corresponding technical data that can currently be ordered. You can see which devices have already been revised by the new labeling on the item at phoenixcontact.com.



Signal conditioners and measuring transducers

System components and accessories

Supply the active 24 V signal conditioners either via the connection terminal blocks or use the modular DIN rail connector as a flexible system solution for power bridging. Especially in multi-channel applications, the DIN rail connector simplifies installation, system expansion, and module replacement, even during operation. Additional accessories, such as programming adapters and feed-through terminal blocks, round off the portfolio.

COMPLETE line

Push-in Technology [®]
Designed by Phoenix Contact

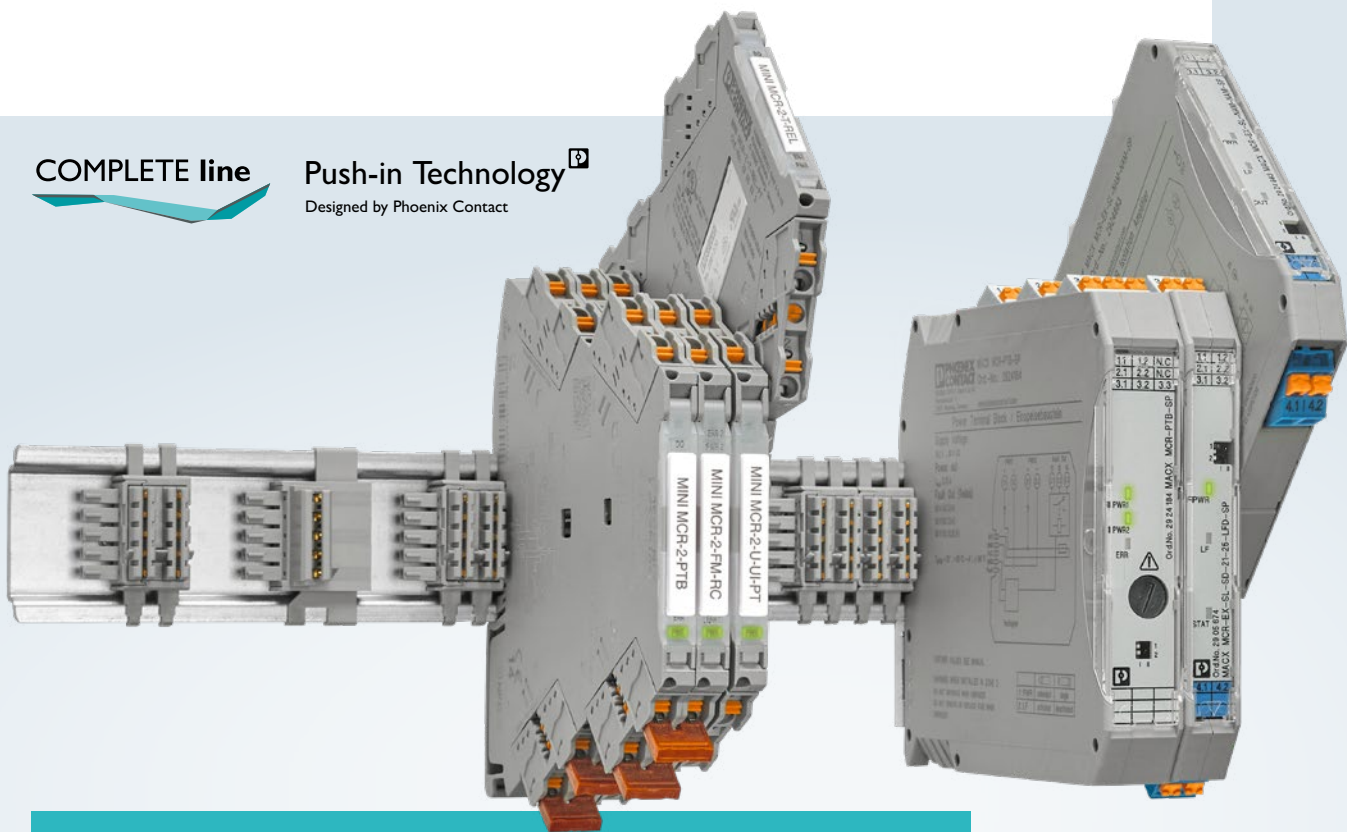

Your advantages

- ✓ The DIN rail connector simplifies power bridging, system expansion, and module replacement, even during operation
- ✓ Flexible supply options: feed-in directly at the module, via a power module, or via a system power supply with a wide range input of 85 V AC ... 264 V AC
- ✓ Convenient diagnostics with the MINI Analog Pro fault monitoring module or the MACX Analog power and fault signaling module
- ✓ Easy adaptation to the Pepperl+Fuchs supply system with the Power Rail adapter

Your advantages in detail

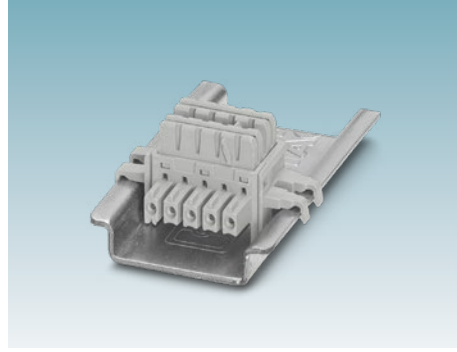
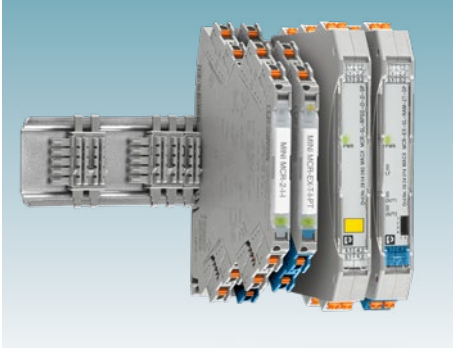

Two families, one system

The TBUS DIN rail connector is compatible with the MINI Analog Pro and MACX Analog product families. This enables you to use the following types of power supply:

- Direct feed-in via the device-internal supply input
- Feed-in via a separate power module
- Supply via a system power supply with wide range input

Robust and safe

All components of the supply system are mechanically protected against contact. The contact elements are located in a robust plastic housing. In addition, the DIN rail connector features coding as well as an aid for error-free and quick insertion of the modules.

System power supply

QUINT POWER power supplies are small in size yet ensure high system availability in the sub 100 W power range. This power supply, which has been developed specifically for MCR technology, enables the signal conditioners to be supplied directly from a 230 V AC supply via the DIN rail connector. Simply snapped onto the TBUS, it delivers a maximum current of 2.5 A.

Easy adaptation to external supply systems

Ideal for system extensions and retrofit installations: the Power Rail adapter for the Pepperl+Fuchs supply system.

The Power Rail adapter enables the MINI Analog Pro and MACX Analog product families to be used as an alternative in existing installations with the Pepperl+Fuchs Power Rail. A tight fit on the Power Rail and mechanical coding ensure secure and vibration-resistant contacting. Installation in zones up to Ex zone 2 possible.

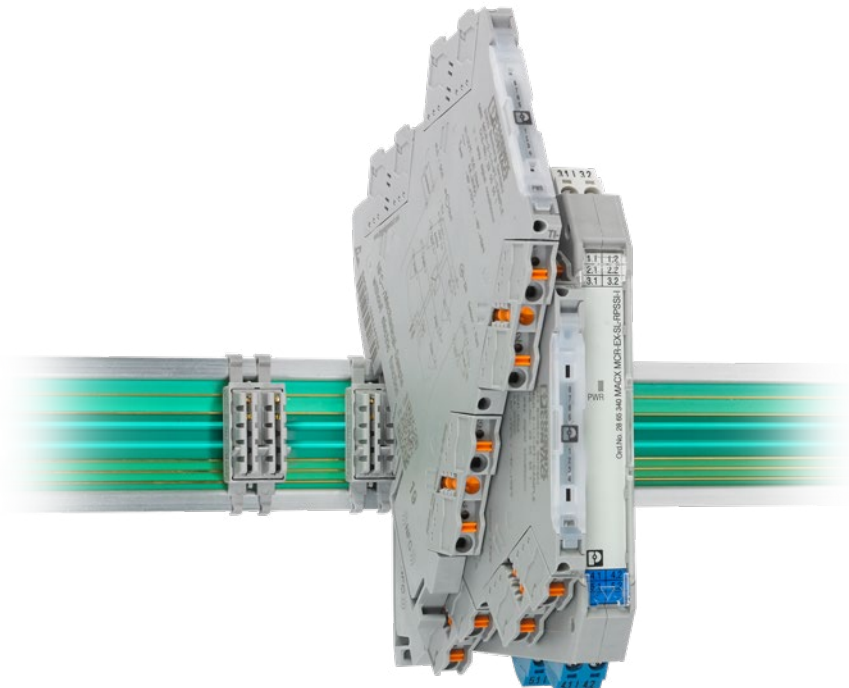

Power supply and diagnostics

Flexible feed-in

The DIN rail connector gives you three device supply options:

Direct feed-in on the module

- Without additional accessories
- For up to 16*) MINI Analog Pro modules
- For up to 32*) MACX Analog modules

Feed-in via a power module of the same shape

- Also enables redundant supply and supply monitoring
- For up to 115*) MINI Analog Pro modules
- For up to 80*) MACX Analog modules

Feed-in via the system power supply

- Also enables redundant supply and supply monitoring
- For up to 60*) MINI Analog Pro modules
- For up to 10*) MACX Analog modules

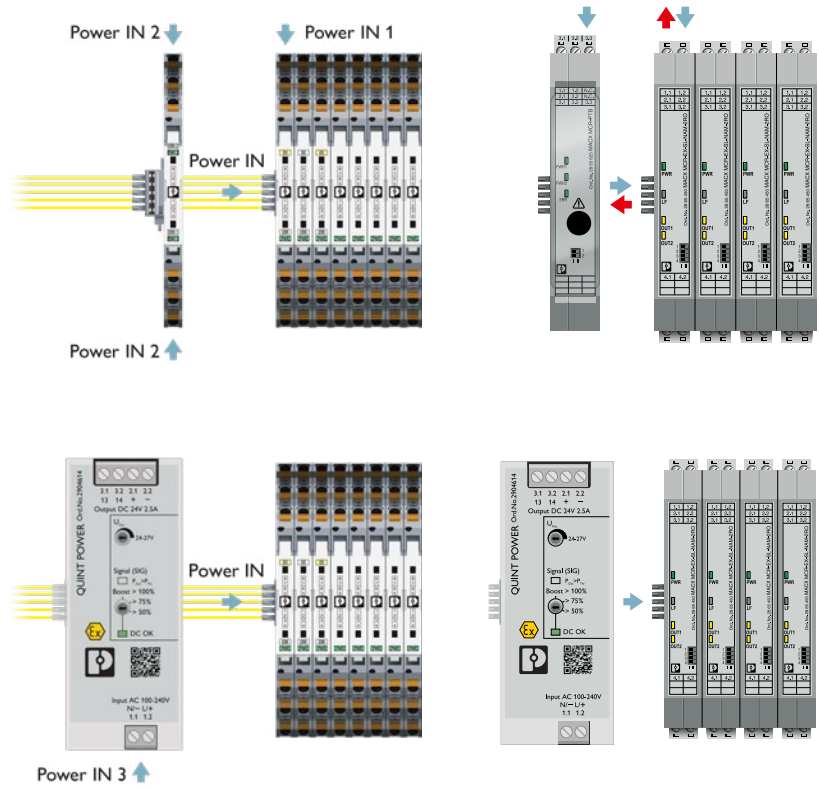

*) The exact number depends on the current consumption of the module type in question. Notes on calculation can be found in our feed-in manual in the download area for the item.

Convenient diagnostics with fault monitoring group error messaging

With group error messaging fault monitoring, the DIN rail connector offers a modular solution for fast error evaluation in multi-channel applications. The MINI Analog Pro and MACX Analog systems are compatible with one another. The following faults are indicated depending on the module type:

- Wire break
- Short circuit
- Supply failure
- Over-range or under-range (MINI Analog Pro only)
- Fuse fault on the power module (MACX Analog only)

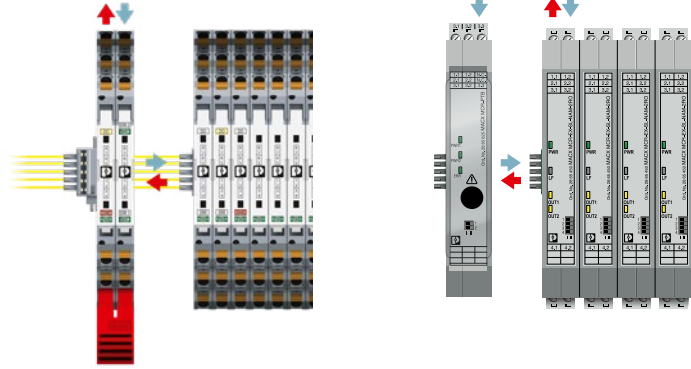

Product overview – system components and further accessories

System components and accessories				
	Description	Connection method	Item no.	Type
	Primary-switched power supply, QUINT POWER. DIN rail mounting, supply of devices via the TBUS DIN rail connector possible, input: 1-phase, output: 24 V DC / 2.5 A	Screw connection	2904614	QUINT4-SYS-PS/1AC/24DC/2.5/SC
	Feed-through terminal block for transmission of signals which are already electrically isolated	Screw connection	2811420	MINI MCR-SL-TB
	MCR power terminal for supplying several MINI Analog modules via the DIN rail connectors, current consumption up to max. 2 A	Screw connection	2864134	MINI MCR-SL-PTB
	The MINI MCR-SL-PTB-FM(-SP) power terminal is used to feed in the supply voltage to the DIN rail connector. The FM power terminal offers the additional function of monitoring in combination with the fault monitoring module.	Screw connection	2902958	MINI MCR-SL-PTB-FM
	The fault monitoring module is used to evaluate and report group errors from the fault monitoring system and monitor supply voltages. The error is reported via an N/O contact. Standard configuration.	Screw connection	2902961	MINI MCR-SL-FM-RC-NC
	Feed-through terminal block with plug-in connection technology for the transmission of signals that are already electrically isolated.	Screw connection	2902068	MINI MCR-2-TB
	Power terminal with plug-in connection technology for delivering the supply voltage to the DIN rail connector. Monitoring of the supply voltages in combination with the fault monitoring module.	Push-in connection	2902067	MINI MCR-2-PTB-PT
		Screw connection	2902066	MINI MCR-2-PTB
	Fault monitoring module with plug-in connection technology for evaluating and reporting group errors from the FM system and for monitoring the supply voltages. Error message via N/C contact. Standard configuration	Push-in connection	2904508	MINI MCR-2-FM-RC-PT
		Screw connection	2904504	MINI MCR-2-FM-RC
	Power and fault signaling module, including the relevant DIN rail connector ME 17,5 TBUS 1,5/ 5-ST-3,81 GY	Push-in connection	2924184 new	MACX MCR-PTB-SP
		Screw connection	2865625 new	MACX MCR-PTB
	Dummy module with no function for connecting unused intrinsically safe signal cables.	Push-in connection	2905846	MACX MCR-EX-DUMMY-ISOLATOR-SP
		Screw connection	2904970	MACX MCR-EX-DUMMY-ISOLATOR



Product overview – system components and further accessories

1

2

3

Signal conditioners and measuring transducers

System components and accessories			
	Description	Item no.	Type
	DIN rail connector (TBUS), 5-pos., for bridging the supply voltage, can be snapped onto NS 35/... DIN rail in accordance with EN 60715	2695439	ME 6,2 TBUS-2 1,5/5-ST-3,81 GY
	DIN rail connector for DIN rail mounting. Universal for TBUS housing. Gold-plated contacts, 5-pos.	2869728	ME 6,2 TBUS-2 1,5/5-ST-3,81 GN
	DIN rail connector, color: gray, nominal current: 8 A (parallel contacts), rated voltage (III/2): 125 V, number of positions: 5, pitch: 3.81 mm, mounting: DIN rail mounting, locking: without, fastening type: without, packaging: packed in a carton, item with gold-plated contacts, bus connector for connecting to electronics housings, 5 parallel contacts	1090049	ME 17,5 TBUS 1,5/ 5-ST-3,81 GY
	End bracket, robust design for DIN rail connectors	2713780	E/ME TBUS NS35 GY
	Programming adapter with USB interface, for programming with software. The USB driver is included in the software solutions for the products to be programmed, such as measuring transducers and motor managers.	2811271	IFS-USB-PROG-ADAPTER
	Bluetooth adapter with micro USB and S-PORT interface for wireless communication with the MINI Analog, MINI Analog Pro, MACX Analog, Interface System Gateways, and PLC logic device series.	2905872	IFS-BT-PROG-ADAPTER
	Near Field Communication (NFC) programming adapter with USB interface for the wireless configuration of NFC-capable products from Phoenix Contact with software. A separate USB driver is not required.	2909681	TWN4 MIFARE NFC USB ADAPTER
	Power rail adapter (ME 6,2 TBUS-PR-ADAPTER), 2-pos., enables MINI and MACX Analog modules to be adapted for supply via universal power rail UPR-03 and UPR-05.	1136500	ME 6,2 TBUS-PR-ADAPTER
	Setpoint value potentiometer, for specifying setpoints individually, resistance value 4.7 kΩ	2940252	EMG 30-SP- 4K7LIN
	Setpoint value potentiometer, for specifying setpoints individually, resistance value 10 kΩ	2942124	EMG 30-SP-10K LIN
	Setpoint potentiometer cascable, for selecting preconfigurable setpoints via a 24 V control signal, resistance value 10 kΩ	2942137	EMG 30-SPK-10K LIN
	The partition plate is used to maintain Ex i isolating distances when Ex i and non-Ex i devices are mounted side by side on a DIN rail.	1430594	MCR-DP

I/O signal marshalling

2

Phoenix Contact provides various solutions for your I/O signal routing in process automation. For classic I/O signal routing, our Termination Carrier provide you with a plug-and-play solution for connecting classic DIN rail devices to the standard I/O cards of your automation system. The VIP I/O marshalling signal marshalling system, which can be equipped flexibly, makes I/O signal marshalling for universal I/O consistent, from the field to the controller.

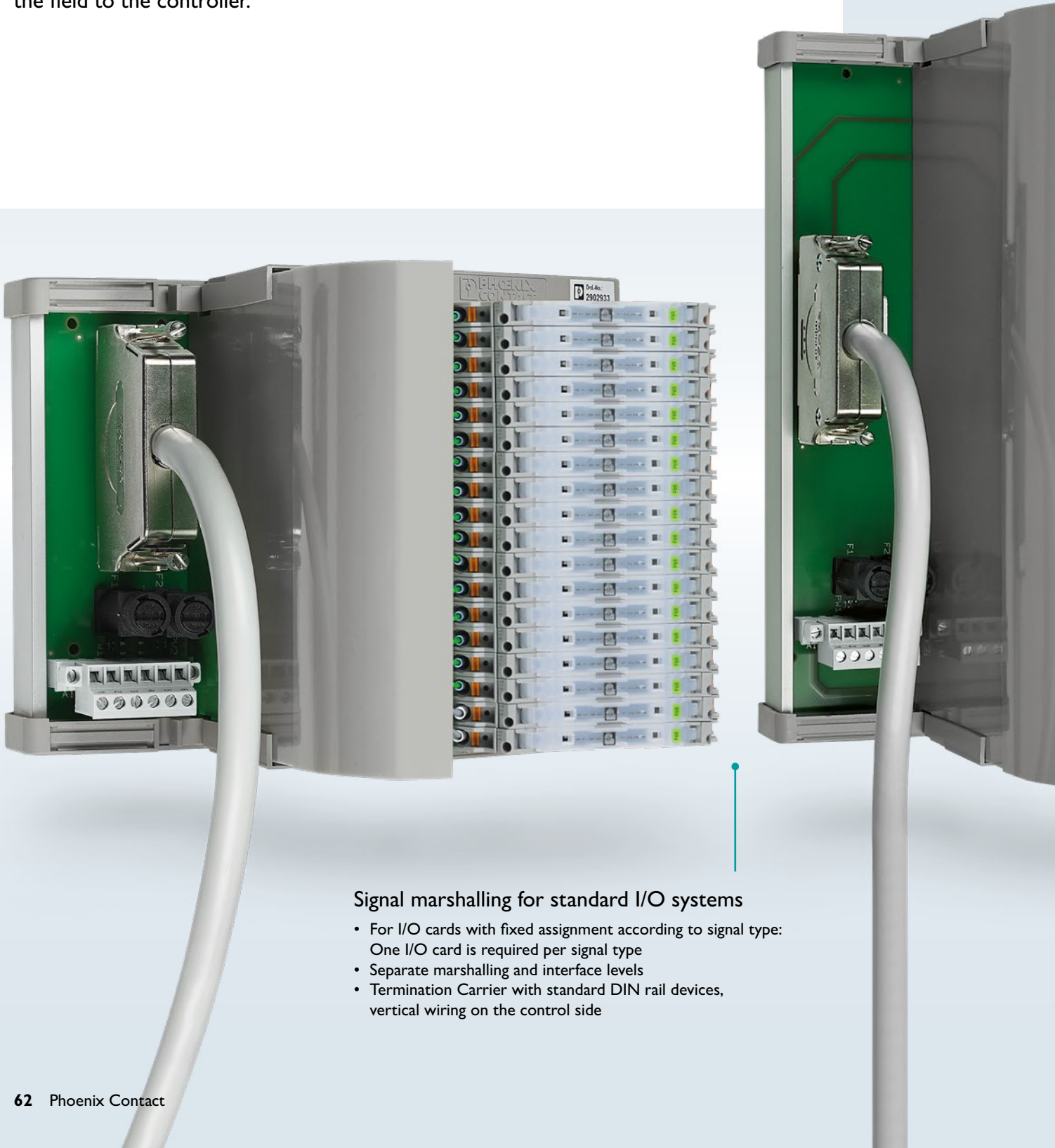

Signal marshalling for standard I/O systems

- For I/O cards with fixed assignment according to signal type:
One I/O card is required per signal type
- Separate marshalling and interface levels
- Termination Carrier with standard DIN rail devices, vertical wiring on the control side

Signal marshalling in comparison

	Standard I/O signal marshalling	Universal I/O signal marshalling
Control input	<p>Standard I/O boards</p> <ul style="list-style-type: none"> A separate I/O board is required for each signal type, e.g., for AI, AO, DI, DO, temperature... Five signal types mean five I/O boards 8 / 16 / 32 channels per board Unnecessary channels take up space and result in additional costs 	<p>Universal I/O boards</p> <ul style="list-style-type: none"> I/O boards with flexible channel assignment for AI, AO, DI, DO, temperature... Five signal types mean one I/O board Channel assignment specified via software
Signal marshalling	<p>Separate marshalling level</p> <ul style="list-style-type: none"> Incoming field signals are sorted by signal type The marshalling level is then wired to the interface level 	<p>Universal remote cabinets</p> <ul style="list-style-type: none"> Marshalling and interface levels are combined in decentralized control boxes Incoming field signals are arbitrarily routed to the input terminal blocks of the Universal I/O system No need to sort the field signals by signal type (except for Safety/Ex i)
Signal processing	<p>Separate interface level with Termination Carriers</p> <ul style="list-style-type: none"> One Termination Carrier is required per signal type, with 8/16/32/ etc. channels Termination board assembly is determined by the signal type Unnecessary channels take up space and result in additional costs 	<p>Universal I/O systems</p> <ul style="list-style-type: none"> Flexible configuration and assembly of channels with input/output accessories (IOAs) that have various interface functions

Signal marshalling for standard I/O systems

Classic signal marshalling

In classic signal marshalling, the field signals arrive in any order and are sorted according to their signal type.

The marshalling level is wired to the interface level, which in turn is wired to the I/O level.

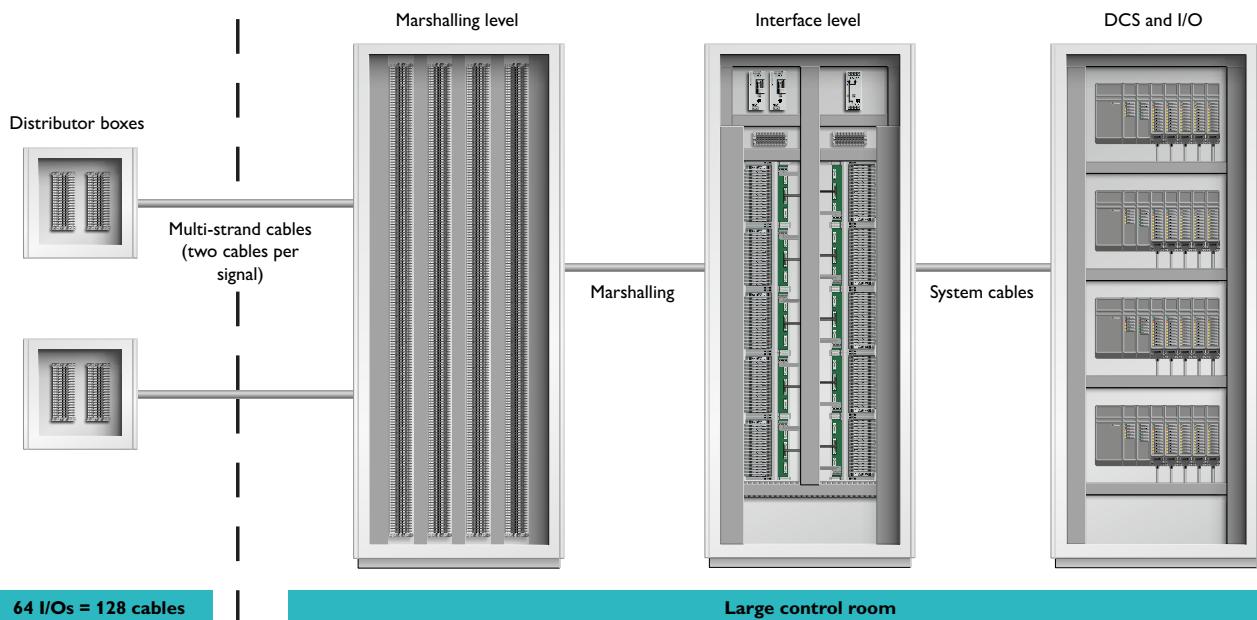

Signal marshalling for Universal I/O systems

Universal Remote Cabinet with VIP I/O marshalling

With Universal Remote Cabinets, the need for large marshalling and interface cabinets is eliminated. The field signals are

routed directly to the VIP I/O marshalling base elements in the control cabinets. The connection to the Universal I/O system

is then made using the system cable. The final connection to the control system is established via a single fiberglass cable.

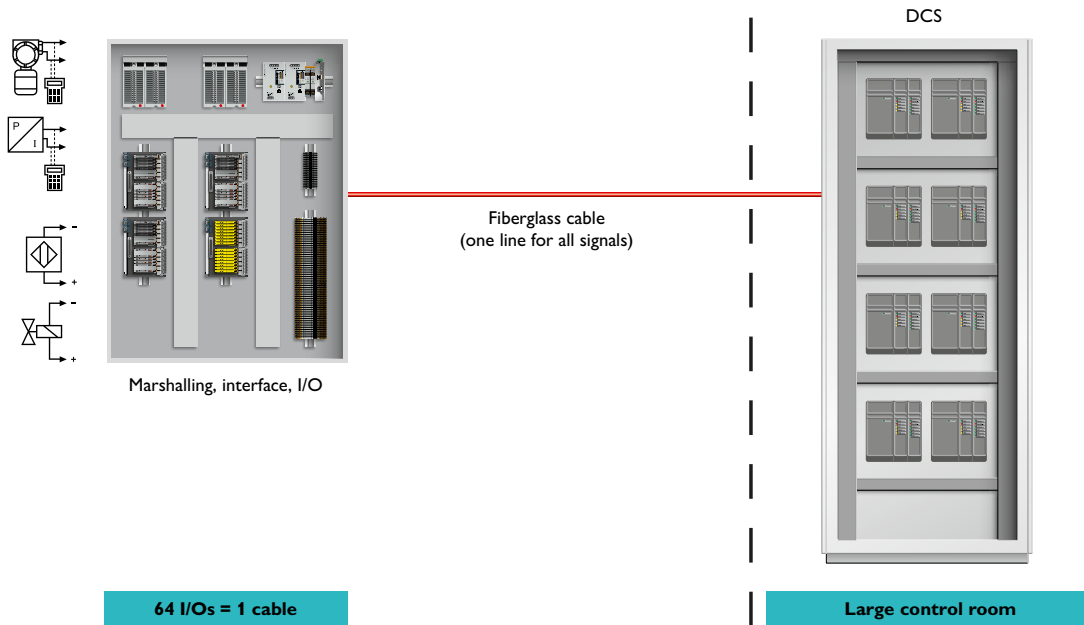

Full flexibility on the interface and marshalling level

Depending on the size of the plant, several thousand signals must be marshalled between the field and control levels to control a continuous process in process engineering plants. Conventional solutions, such as interface blocks mounted on the DIN rail, however, require the exact signal type to be known at an early stage. Moreover, signals need to be marshalled again in the process in order to wire the field signals to the individual function blocks, such as to relays for digital output signals.

With the Universal I/O approach on the control level, you already achieve improvements here compared to the classic signal marshalling. Instead of the 8/16/32/64-channel blocks for each signal type, with Universal I/O cards you use software to adapt the individual channels to the necessary function. The flexible I/O marshalling system VIP I/O marshalling has been specially designed for use on Universal I/O systems. The solution offers the same flexibility at the interface and marshalling

level as the Universal I/O systems at the I/O level.

Pluggable input/output accessories with various interface functions

The optional plug-in input-output accessories (IOAs) are blocks with various electrical functions for signal processing. This is Universal marshalling – from the field to the controller.

The following IOAs are available:

- Passive modules
- Relays
- Safety relays
- Signal conditioners
- Measuring transducers
- Fuse modules
- Special functions

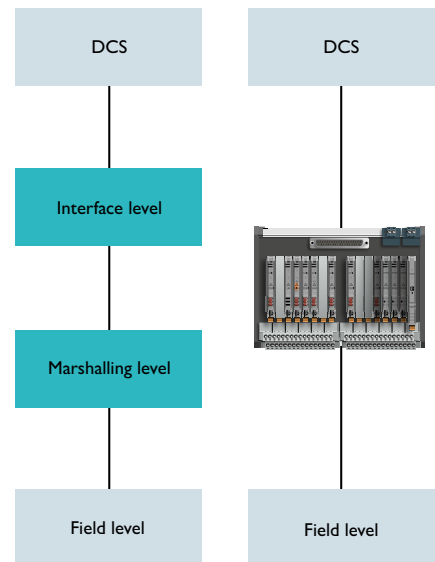

VIP I/O marshalling makes Universal I/O truly universal – from the field to the controller

I/O signal marshalling

Signal marshalling for standard I/O systems

Our compact and robust Termination Carriers are plug-and-play solutions for fast and error-free connection of a large number of signals from the field to your automation system. By using standard DIN rail devices, you only need one engineering design for standard DIN rail and system applications.

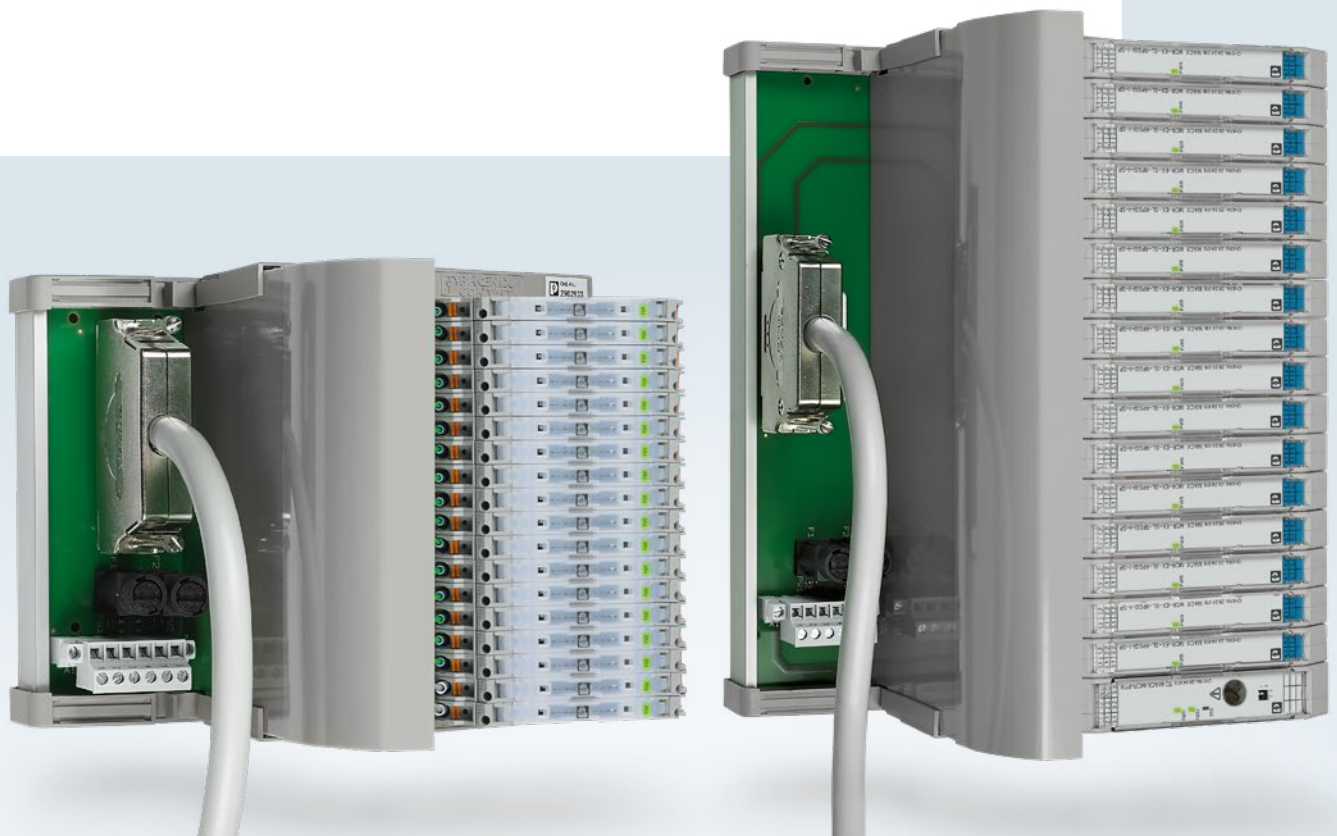

Your advantages

- ✓ Space-saving with the compact design
- ✓ High system availability with the robust housing with mechanically decoupled termination PCB
- ✓ Simple wiring with pluggable, coded cable sets and preassembled system cables
- ✓ Optimum adaptation with a variety of system connectors and front adapters for the I/O cards of various automation systems
- ✓ Service-friendly due to hot-swap module replacement and easily accessible connection elements

Your advantages in detail



High system availability

The stable, vibration-proof aluminum carrier has a profile for accommodating standard DIN rail devices. In addition, the termination PCB is mechanically decoupled. The passive design of the termination PCB provides additional failsafe performance: it does not contain any active components.

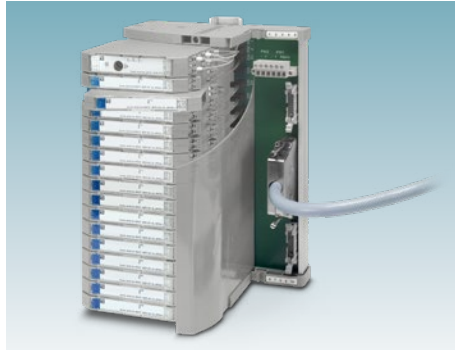

Easy installation and engineering

Easily accessible terminal points and hot-swap module replacement allow you to perform installation servicing more easily. You can connect the products to the Termination Carrier PCB quickly and safely with pluggable and coded cable sets. By using standard DIN rail devices, you only need one engineering design for standard DIN rail and system applications.



Optimum adaptation

Pitch-free profile lengths and a wide range of system connectors and front adapters allow you to adapt optimally to the I/O cards of various automation systems. In addition to the universal Termination Carriers with 1:1 pinning and optional HART® signal decoupling, various control system-specific versions are available.

The space-saving solution for low signal volumes

The MINI Analog Pro system adapter provides you with a time-saving plug-and-play wiring solution. The easily pluggable system adapter lets you connect eight MINI Analog Pro signal conditioners in any combination to your controller quickly and error-free.

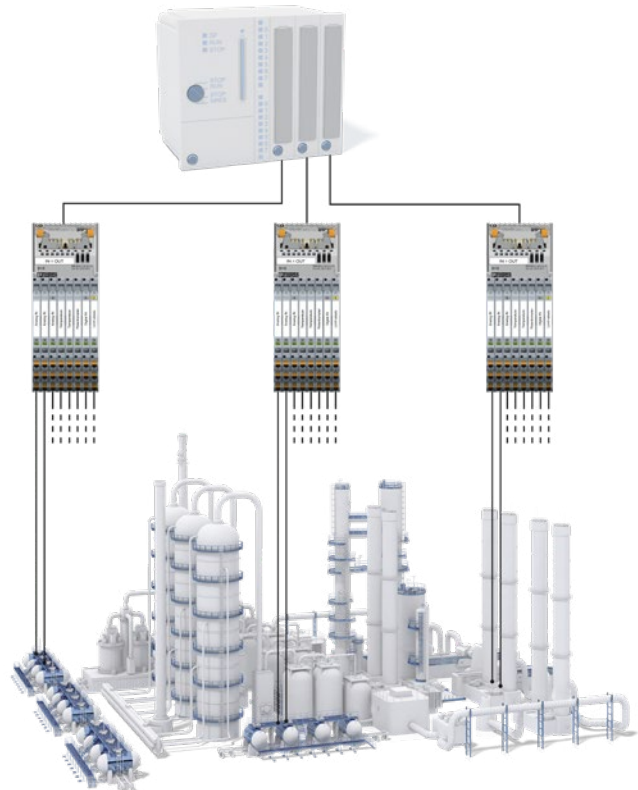

Product overview – Termination Carriers for standard I/O systems



Your individual solution

In addition to our universal Termination Carriers, we also provide solutions for the I/O boards of various controller manufacturers.

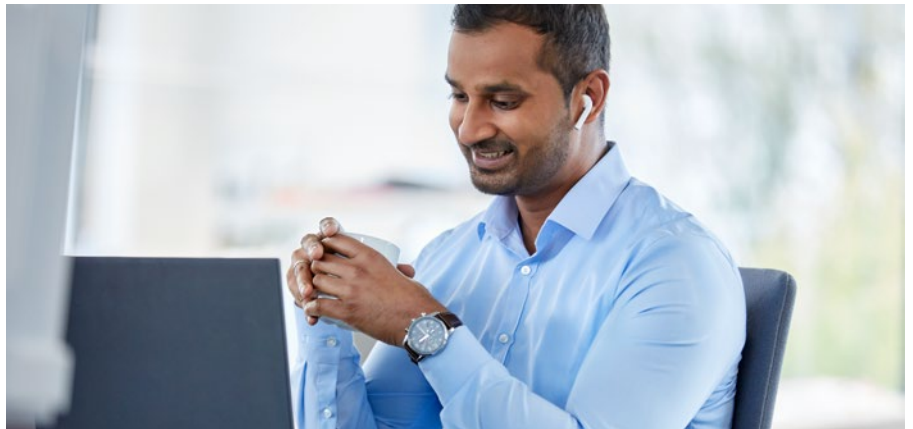



Please contact us for more information.





Termination Carriers





	Description	Item no.	Type
	Universal Termination Carrier for connecting 16 MINI Analog Pro signal conditioners to digital or analog I/O cards, via D-SUB connector, 37-pos. (1:1 connection)	2906639	TC-D37SUB-ADIO16-MP-P-UNI
	Universal Termination Carrier for connecting 16 MINI Analog Pro signal conditioners to digital or analog I/O cards, via D-SUB connector, 37-pos. (1:1 connection), with HART multiplexer connection	2906640	TC-D37SUB-AIO16-MP-PS-UNI

Accessories

	Description	Connection method	Item no.	Type
	Feed-through terminal block with plug-in connection technology for the transmission of signals that are already electrically isolated.	Screw connection	2902068	MINI MCR-2-TB
	Power terminal with plug-in connection technology for delivering the supply voltage to the DIN rail connector. Monitoring of the supply voltages in combination with the fault monitoring module.	Push-in connection	2902067	MINI MCR-2-PTB-PT
		Screw connection	2902066	MINI MCR-2-PTB
	Fault monitoring module with plug-in connection technology for evaluating and reporting group errors from the FM system and for monitoring the supply voltages. Error message via N/C contact. Standard configuration	Push-in connection	2904508	MINI MCR-2-FM-RC-PT
		Screw connection	2904504	MINI MCR-2-FM-RC
	HART multiplexer for the online configuration and diagnostics of HART-compatible field devices as well as the continuous documentation of process variables and states using a PC or management system, for mounting on NS 35/7.5 or NS 32	Flat-ribbon cable, 14-pos. (included) (HART FSK) / D-SUB 9 female connector (RS-485)	2865599	MACX MCR-S-MUX
	Assembled round cable; Connection 1: IDC/FLK female strip (1 x 14-pos., 180° outlet); Connection 2: IDC/FLK female strip (1 x 14-pos., 90° outlet); Cable length: variable		2318457	VIP-CAB-FLK14-0,14/...

Product overview – Termination Carriers for standard I/O systems

Termination Carriers			
	Description	Item no.	Type
	Universal Termination Carrier for connecting 16 MACX Analog Ex i signal conditioners to digital or analog I/O cards, via D-SUB connector, 37-pos. (1:1 connection)	2924854	TC-D37SUB-ADIO16-EX-P-UNI
	Universal Termination Carrier for connecting 16 MACX Analog Ex i signal conditioners to digital or analog I/O cards, via D-SUB connector, 37-pos. (1:1 connection), with HART multiplexer connection	2902932	TC-D37SUB-AIO16-EX-PS-UNI
	Universal Termination Carrier for connecting 16 two-channel MACX Analog Ex i signal conditioners to digital or analog I/O cards, via two D-SUB connectors, 37-pos. (1:1 connection)	2904684	TC-2D37SUB-ADIO32-2EX-P-UNI

Accessories			
	Description	Item no.	Type
	Power and fault signaling module with screw connection, only for use on the Termination Carrier, excluding corresponding DIN rail connector	2904673	TC-MACX-MCR-PTB
	Cable set for signal transmission and power supply on the Termination Carrier for signal conditioners from the MACX Analog Ex series. Connection of terminal points 3.2 and 2.2 (signal transmission for active input cards) to the signal PCB.	2904446	TC-C-MAX2-SC-32220000
	HART multiplexer for the online configuration and diagnostics of HART-compatible field devices as well as the continuous documentation of process variables and states using a PC or management system, for mounting on NS 35/7.5 or NS 32	2865599	MACX MCR-S-MUX
	Assembled round cable; Connection 1: IDC/FLK female strip (1 x 14-pos., 180° outlet); Connection 2: IDC/FLK female strip (1 x 14-pos., 90° outlet); Cable length: variable	2318457	VIP-CAB-FLK14-0,14/...

Product overview – Termination Carriers for standard I/O systems

PSR safety relays

Our TÜV-certified SIL coupling relays for safe switch-on and switch-off enable the electrical isolation of signals up to SIL 3. System downtimes can be reduced to a minimum by diagnostic functions, such as integrated proof test and line load monitoring. The SIL 3 coupling relays with ATEX, G3 coating, and temperature range up to 70°C are suitable for special applications in the process industry. The Termination Carriers are designed to accommodate the PSRmini and PSRclassic product families.

PSRmini

With an overall width starting from 6 mm, PSRmini relays are the narrowest SIL coupling relays on the market.

- Overall widths of 6.8 mm, 12.5 mm, and 17.5 mm
- For safe switch-on and safe shutdown

- LEDs enable SIL-qualified diagnostics directly on the module
- One to three enabling current paths
- Active error feedback directly to the controller by DCS test pulse filters ensures short downtimes during planned maintenance phases

PSRclassic

The conventional coupling relays are characterized by a wide range of features and versions. The housing width corresponds to the market standard.



- Overall width from 17.5 mm
- SIL coupling relays for safe switch-off
- Three safe relay contacts and contact multiplication

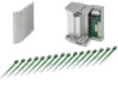

Termination Carriers

	Description	Item no.	Type
	Universal Termination Carrier for connecting 16 MINI PSR SIL coupling relays to digital output cards, via D-SUB connector, 37-pos. (1:1 connection)	2906609	TC-D37SUB-DO16-PS-P-UNI

Accessories

	Description	Connection method	Item no.	Type
	The fault monitoring module is used to evaluate and report group errors from the fault monitoring system and monitor supply voltages. The error is reported via an N/O contact. Standard configuration.	Screw connection	2902961	MINI MCR-SL-FM-RC-NC
	The MINI MCR-SL-PTB-FM(-SP) power terminal is used to feed in the supply voltage to the DIN rail connector. The FM power terminal offers the additional function of monitoring in combination with the fault monitoring module.	Screw connection	2902958	MINI MCR-SL-PTB-FM

Digital OUT

	Description	Item no.	Type
	Coupling relay for SIL 3 high and low-demand applications, couples digital output signals to the I/O, 1 enabling current path, 1 confirmation current path, safe-state-off applications, test pulse filter, fixed screw terminal block	2702524	PSR-PS22-1NO-1NC-24VDC-SC

Product overview – Termination Carriers for standard I/O systems



1



2

3

I/O signal marshalling

Termination Carriers			
	Description	Item no.	Type
	Universal Termination Carrier for redundantly connecting 16 PSR-FSP modules to digital output cards, via two D-SUB connectors, 37-pos. (1:1 connection). Solution for Emergency Shut Down (ESD) applications	2902913	TC-2D37SUB-DO16-ESD-AR-UNI

Digital OUT			
	Description	Item no.	Type
	Safe coupling relay for SIL 3 high- and low-demand applications, couples digital output signals to the periphery, one enabling current path, one signal contact, module for safe-state-off applications, test pulse filter, fuse, plug-in screw connection, width: 17.5 mm	2981978	PSR-SCP- 24DC/FSP/1X1/1X2
	Safe coupling relay for SIL 3 high- and low-demand applications, couples digital output signals to the periphery, one enabling current path, one signal contact, module for safe-state-off applications, test pulse filter, fuse, plug-in Push-in connection, width: 17.5 mm	2981981	PSR-SPP- 24DC/FSP/1X1/1X2
	Safe coupling relay for SIL 2 high- and low-demand applications, couples digital output signals to the periphery, two enabling current paths, one signal contact, module for safe-state-off applications, integrated test pulse filter, plug-in screw connection, width: 17.5 mm	2986575	PSR-SCP- 24DC/FSP/2X1/1X2
	Safe coupling relay for SIL 3 high- and low-demand applications, couples digital output signals to the periphery, two enabling current paths, one signal contact, module for safe-state-off applications, integrated test pulse filter, plug-in screw connection, width: 17.5 mm	2986960	PSR-SCP- 24DC/FSP/2X1/1X2

Accessories			
	Description	Item no.	Type
	Cable set for signal transmission on the Termination Carrier for coupling relays from the PSR-FSP series. Connection of terminal points A1 and A2 (signal transmission) to the signal PCB. Suitable for PSR-SCP-24DC/FSP/1X1/1X2 (item no. 2981978).	2903389	TC-C-PSR3-SC-A10000A20000
	Cable set for signal transmission on the Termination Carrier for coupling relays from the PSR-FSP series. Connection of terminal points A1 and A2 (signal transmission) as well as 31 and 32 (confirmation). Suitable for PSR-SCP-24DC/FSP/2X1/1X2 (item no. 2986960) and PSR-SCP-24DC/FSP/2X1/1X2 (item no. 2986575).	2903390	TC-C-PSR3-SC-A10000A23132
	Jumper plug, for looping through the checkback contacts of unused module slots. Use on the termination carrier for safety relay modules from the PSR-FSP series.	2903388	TC-C-PTSM-50-00000000J1J1

I/O signal marshalling

Signal marshalling for Universal I/O systems

Design your universal I/O marshalling system consistently from the field to the control level with the flexible I/O marshalling system: VIP I/O marshalling. The system combines signal marshalling and processing in a controller-independent solution for your universal I/O system. Pluggable input/output accessories with various interface functions enable universal configuration of individual channels.

COMPLETE line

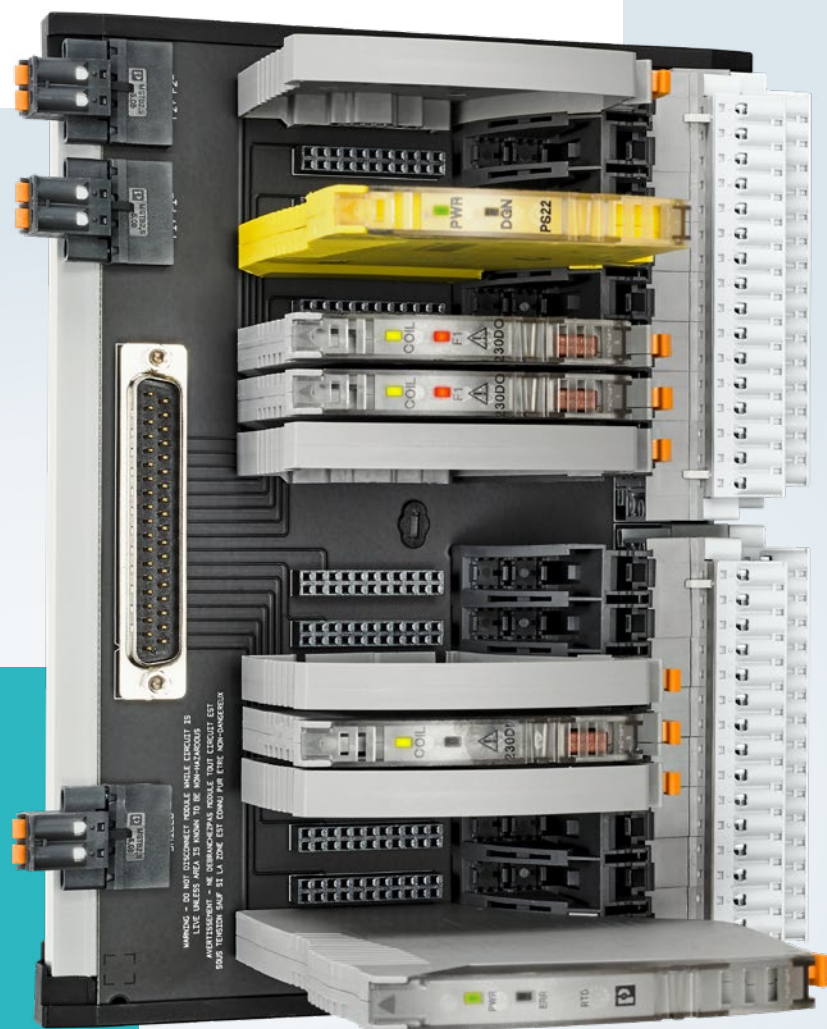

Your advantages

- ✓ Shorter project duration with a consistent Universal I/O approach
- ✓ Changes to the I/O assignment possible in every project phase with plug-in IOAs
- ✓ Lower number of control cabinets: additional marshalling cabinets are not necessary
- ✓ Reduced wiring effort with controller-specific system cabling solutions
- ✓ Easy migration into existing systems: reducing downtimes during retrofit work



Your advantages in detail

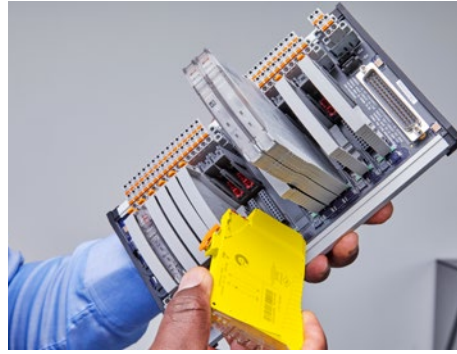

Simplified planning

Instead of the 8/16/32/64-channel blocks for each signal type, with Universal I/O boards you use software to adapt the individual channels to the necessary function. This means that only the number of signals must be taken into account during planning. The signal type is adapted later.

Universal and reliable

From the simple terminal block, through relays, right up to signal conditioners with explosion protection and functional safety: The wide range of IOAs ensures that all types of signals from the field are reliably processed and transmitted to the control level. Plug-in capability and state-of-the-art signal processing technologies increase system availability and reduce downtimes.

Reduces wiring effort, saves space

In distributed Universal Remote Cabinets, field signals are applied directly to the base elements, processed, and connected to the Universal I/O cards via system cable. Large marshalling and interface cabinets are no longer needed. Laborious cross-wiring is no longer necessary.

Significant reduction in project lead times

The Universal I/O concept, in combination with intelligent signal marshalling, offers significant advantages for planning and implementing complex process automation projects. Project information that was

previously required at an early stage, such as the number of individual field signal types, is now only required at a later stage of the project. This simplifies planning and procuring hardware. In addition, individual

project steps can be processed in parallel due to the increased flexibility of the approach. Overall, this shortens project lead times significantly, which also reduces total investment costs.

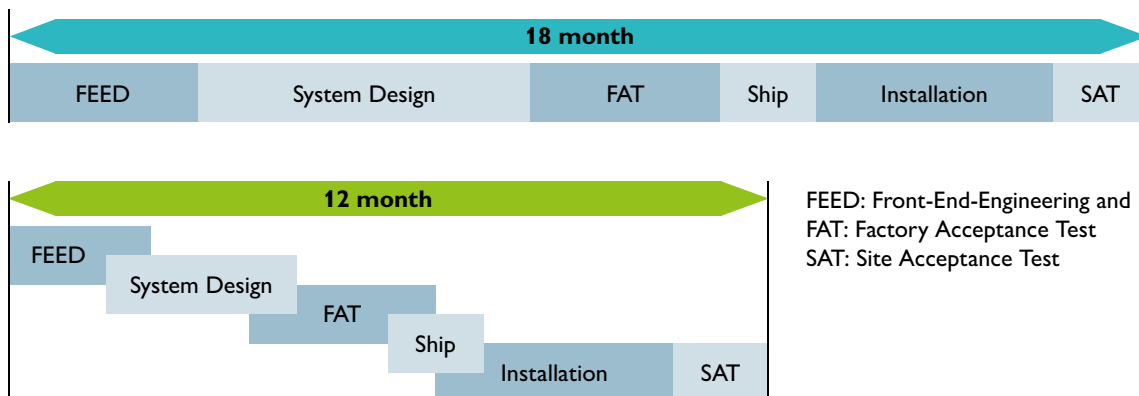

FEED: Front-End-Engineering and Design
 FAT: Factory Acceptance Test
 SAT: Site Acceptance Test



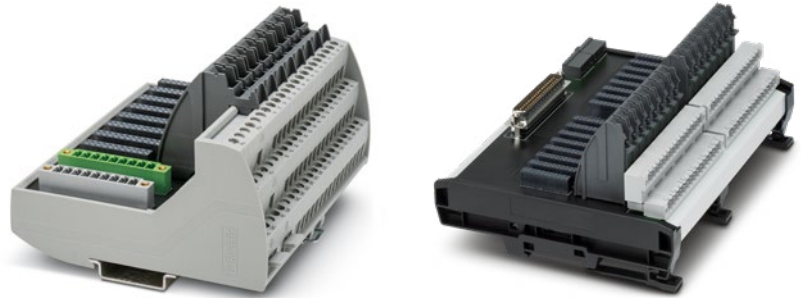

Product overview – VIP I/O marshalling for universal I/O systems

Base elements

The robust base elements have 8 or 16 freely assignable slots for the function modules, so-called input-output accessories. The base elements are connected to the field wiring, transfers the field signals to the function modules and from there to the system cable. Choose between controller-specific and manufacturer-independent base elements.



Base elements

	Description	Item no.	Type
	16-channel VIP I/O marshalling base element with 37-pos. D-SUB connector for universal use. Plug-in field and supply terminals available as accessories. Either with screw or Push-in connection technology.	1065476	BASE-MSTB/D37M/16CH/EX
	16-channel VIP I/O marshalling base element for universal use. Plug-in field and supply terminals available as accessories. Either with screw or Push-in connection technology. Compatible with the Tricon CX DCS series (D-SUB 50).	2908788	VIP/MSTB/D50M/BASE/16CH/CX/EX
	8-channel VIP I/O marshalling base element for universal use. All connections as screw connection technology. This module with the D-SUB 25 connector is pin compatible with the Foxboro I/A series DCS.	2906595	VIP/S/D25M/BASE 1-8/L/C/EX
	8-channel VIP I/O marshalling base element for universal use. All connections as screw connection technology. With the COMBICON connector, compatible with the Honeywell C300 and RUSIO series.		
	Marking for channels 1–8 and painting.	2907186	VIP/S/MC/BASE 1-8/L/C/EX
	Marking for channels 9–16 and painting.	2907187	VIP/S/MC/BASE 9-16/L/C/EX
	Marking for channels 17–24 and painting.	2907209	VIP/S/MC/BASE 17-24/L/C/EX
	Marking for channels 25–32 and painting.	2907210	VIP/S/MC/BASE 25-32/L/C/EX
	Marking for channels 1–8.	2906596	VIP/S/MC/BASE 1-8/L/EX
	Marking for channels 9–16.	2906630	VIP/S/MC/BASE 9-16/L/EX
	Marking for channels 17–24.	2907024	VIP/S/MC/BASE 17-24/L/EX
Marking for channels 25–32.	2907025	VIP/S/MC/BASE 25-32/L/EX	





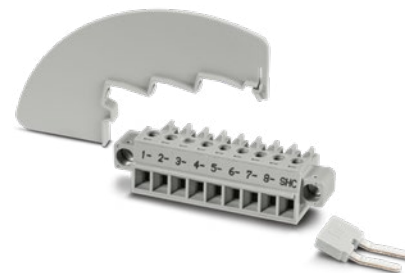

Accessories

Depending on the base element, connector sets with four or six connection terminal blocks per channel are available for the field connection, either with screw or Push-in connection. The partition plates ensure a physical separation between field terminals and power bus terminals or power supply components on the VIP socket module. You can also choose between fuse sets with different current ratings. A wide range of standard and controller-specific system



cables connects your base element to the respective I/O systems.



Accessories



	Description	Item no.	Type
	Connector set for standard applications for use with BASE-MSTB/D37M/16CH/EX VIP I/O marshalling base element with Push-in connection.	1193570	PLUGKIT-GY/FKC/16CH-1-16
	Connector set for standard applications for use with BASE-MSTB/D37M/16CH/EX VIP I/O marshalling base element with screw connection.	1193535	PLUGKIT-GY/MSTB/16CH-1-16
	Connector set for use with VIP/MSTB/D50M/BASE..., Push-in connections	2910417	VIP/P/FKC/KIT CX
	Connector set for use with VIP/MSTB/D50M/BASE..., screw connections	2910416	VIP/S/MVSTBR/KIT CX
	Pair of screw terminal block connectors for connection to the VIP base module with the identification 1-8	2907032	VIP/S/Front-MC/KIT 1-8
	Pair of screw terminal block connectors for connection to the VIP base module with the identification 9-16	2907270	VIP/S/Front-MC/KIT 9-16
	Pair of screw terminal block connectors for connection to the VIP base module with the identification 17-24	2907271	VIP/S/Front-MC/KIT 17-24
	Pair of screw terminal block connectors for connection to the VIP base module with the identification 25-32	2907272	VIP/S/Front-MC/KIT 25-32
	Pair of screw terminal block connectors for connection to the VIP base module with the identification 1-8	2907031	VIP/S/MC/KIT 1-8
	Pair of screw terminal block connectors for connection to the VIP base module with the identification 9-16	2907267	VIP/S/MC/KIT 9-16
	Pair of screw terminal block connectors for connection to the VIP base module with the identification 17-24	2907268	VIP/S/MC/KIT 17-24
	Pair of screw terminal block connectors for connection to the VIP base module with the identification 25-32	2907269	VIP/S/MC/KIT 25-32

Product overview – VIP I/O marshalling for universal I/O systems

Accessories			
	Description	Item no.	Type
	VIP I/O marshalling partition plate for safe isolation between non-Ex i and Ex i assembled base modules for Honeywell systems. The partition plate is mounted directly on the DIN rail at the end of the base module.	2908555	VIP/U/RAIL 3L DIVIDER
	VIP I/O marshalling partition plate for safe isolation between non-Ex i and Ex i plug-in modules on a base module in VIP design. The partition plate is mounted directly on the base module between the plug-in IOAs.	2907715	VIP/S/BASE 3L DIVIDER
	VIP I/O marshalling partition plate for safe isolation between Ex i plug-in modules and the power supply of the VIP/MSTB/D50M/BASE/16CH/CX/EX base module. The partition plate is mounted directly on the base module between the plug-in IOAs and the power supply.	2910139	VIP/UM-PRO/BASE DIVIDER/CX

Accessories			
	Description	Item no.	Type
	Fuse set, quantity: 10 pieces, nominal current: 0.315 A, Tripping characteristic: slow-blow (T)	1192057	FUSE/TE5/315MA/T-10PCS
	Fuse set, quantity: 10 pieces, nominal current: 1 A, Tripping characteristic: slow-blow (T)	1053562	FUSE/TE5/1A/T-10PCS
	Fuse set, quantity: 10 pieces, nominal current: 2.5 A, Tripping characteristic: slow-blow (T)	1214124	FUSE/TE5/2.5A/T-10PCS
	Fuse set, quantity: 10 pieces, nominal current: 3.15 A, Tripping characteristic: slow-blow (T)	1053563	FUSE/TE5/3.15A/T-10PCS

Product overview – VIP I/O marshalling for universal I/O systems

Accessories – cables		
	VIP 16-channel cable for use with Honeywell C300 universal I/O	
		
	CAB-MSTB32/2XMC9/18/*M/C3/S	CAB-MSTB32/2XMC9/22/*M/C3/S
Cable length	AWG 18 signal line	AWG 22 signal line
0.4 m	2908403	2908328
0.5 m	2908404	2906874
1 m	2908405	2906884
2 m	2908406	2906886
3 m	2908407	2906887
4 m	2908408	2906888
6 m	2908409	2906889
8 m	2908410	2907783
10 m	2908411	2907784
14 m		2910400
15 m	2908412	1065475
16 m		2910401
17 m		2910403
18 m		1013239
19 m		1013240
20 m	2908413	2907785
22 m		2910404
23 m		2910405
25 m		1065474
32 m		1013241
35 m		2909901
36 m		2910406



Product overview – VIP I/O marshalling for universal I/O systems

Analog IN

Repeater power supplies and input signal conditioners are used in a wide range of applications in the process industry. They supply passive field devices with the necessary power, amplify signals, and filter unwanted interfering signal from the measuring circuit. The IOAs are HART®-transparent and as an option have SIL and Ex i approval.



Analog IN

	Description	Item no.	Type
	Ex i repeater power supply and input signal conditioner, HART-transparent, for VIP I/O marshalling base elements: Transmits 0/4 mA ... 20 mA signals from the Ex area to a load (active or passive) in the safe area. 3-way electrical isolation, SIL 2, SC 3 in accordance with IEC 61508	1085761	IOA MCR-EX-RPSS-I-I
	Repeater power supply and input signal conditioner, HART-transparent, for VIP I/O marshalling base elements: Transmits 0/4 mA ... 20 mA signals to a load (active or passive). 3-way electrical isolation, SIL 2, SC 3 in accordance with IEC 61508	1085774	IOA MCR-RPSS-I-I

Analog OUT

Analog output drivers are needed to drive a measuring signal from the controller into the field via a load. This is used, for example, to operate P/I converters, regulating valves, and displays. The IOAs are HART®-transparent and have SIL approval and, as an option, EX i approval.



Analog OUT

	Description	Item no.	Type
	Ex i output signal conditioner, HART-transparent, for VIP I/O marshalling base elements: Isolates and transmits 0/4 ... 20 mA signals with intrinsic safety to a load in the Ex area. 3-way electrical isolation, line fault detection, SIL 2, SC 3 in accordance with IEC 61508	1044642	IOA MCR-EX-IDS-I-I
	Output signal conditioner, HART-transparent, for VIP I/O marshalling base elements: Isolates and transmits 0/4 ... 20 mA signals to a load. 3-way electrical isolation, line fault detection, SIL 2, SC 3 in accordance with IEC 61508	1176865	IOA MCR-IDS-I-I



Product overview – VIP I/O marshalling for universal I/O systems

Digital IN

Binary input signals in the process industry are often simple switches or NAMUR proximity sensors. NAMUR signal conditioners operate these switches and transmit these signals out of the intrinsic safety area. IOA relay modules are used for the electrically isolated coupling of field devices (<230 V) to digital inputs. The IOAs are available with SIL and optionally with Ex i approval.



Digital IN



	Description	Item no.	Type
	Relay module for VIP I/O marshalling base elements. For the electrically isolated coupling of 24 V DC field devices to digital inputs. Integrated fuse and fuse failure indication.	2910155	IOA REL 24V DI/BFI/1.0A/EX
	Relay module for VIP I/O marshalling base elements. For the electrically isolated coupling of 120 V AC field devices to digital inputs. Integrated fuse and fuse failure indication.	2910157	IOA REL 120V DI/1.0A/EX
	Relay module for VIP I/O marshalling base elements. For the electrically isolated coupling of 230 V AC field devices to digital inputs. Integrated fuse and fuse failure indication.	2910423	IOA REL 230V DI/1.0A/EX
	Cable monitoring module for VIP I/O marshalling base elements. Enables cable fault monitoring when using standard switching contacts in safety applications. Both wire breaks and short circuits can be detected.	1048209	IOA LM-DI/R/RUSIO/EX
	Digital-to-analog converter for VIP I/O marshalling base elements. For connection of four digital inputs and conversion to a single analog 4...20 mA signal. Saves three I/O channels.	1145061	IOA DAC-4DI/AI/EX

Digital OUT

Solenoid driver are used to transmit control signals to solenoid valves located in the intrinsic safety area. Relay modules for digital output signals switch loads up to 3 A and 230 V into the field. The IOAs are available with SIL and optionally with Ex i approval.



Digital OUT

	Description	Item no.	Type
	Relay module for VIP I/O marshalling base elements. For switching 24 V DC loads up to max. 3 A. Integrated fuse and fuse failure indication. N/O contact or N/C contact can be used.	2910153	IOA REL 24V DO/BFI/3.0A/EX
	Relay module for VIP I/O marshalling base elements. For switching 120 V AC loads up to max. 3 A. Integrated fuse and fuse failure indication. N/O contact or N/C contact can be used.	2910154	IOA REL 120V DO/BFI/3.0A/EX
	Relay module for VIP I/O marshalling base elements. For switching 230 V AC loads up to max. 3 A. Integrated fuse and fuse failure indication. N/O contact can be used.	2910421	IOA REL 230V DO/BFI/NO/3.0A/EX
	Relay module for VIP I/O marshalling base elements. For switching 230 V AC loads up to max. 3 A. Integrated fuse and fuse failure indication. N/C contact can be used.	2910422	IOA REL 230V DO/BFI/NC/3.0A/EX
	Plug-in SIL coupling relay as an input/output accessory for VIP base module, SIL 3 high- and low-demand applications, safe-state-off, couples digital output signals to the periphery, one enabling current path, one confirmation current path, test pulse filter	2702971	IOA-PSR-PS22-1NO-1NC-24DC
	Ex i solenoid driver for VIP I/O marshalling base elements: for controlling Ex i solenoid valves in potentially explosive areas, logic input, no-load voltage 15.95 V, current limitation at 50 mA, line fault transparency, up to SIL 3 in accordance with IEC 61508	1095564	IOA MCR-EX-SD-16-50
	Ex i solenoid driver for VIP I/O marshalling base elements: for controlling Ex i solenoid valves in potentially explosive areas, logic input, no-load voltage 19.95 V, current limitation at 25 mA, line fault transparency, up to SIL 3 in accordance with IEC 61508	1095563	IOA MCR-EX-SD-20-25
	Ex i solenoid driver for VIP I/O marshalling base elements: for controlling Ex i solenoid valves in potentially explosive areas, logic input, no-load voltage 20.85 V, current limitation at 48 mA, line fault transparency, up to SIL 3 in accordance with IEC 61508	1291156	IOA MCR-EX-SD-21-48
	Ex i solenoid driver for VIP I/O marshalling base elements: for controlling Ex i solenoid valves in potentially explosive areas, logic input, no-load voltage 22.3 V, current limitation at 38 mA, line fault transparency, up to SIL 3 in accordance with IEC 61508	1085763	IOA MCR-EX-SD-23-38



Product overview – VIP I/O marshalling for universal I/O systems

Temperature

Monitoring temperatures in process technology plants is a fundamental requirement. Resistance thermometers and thermocouples are often used for this purpose. IOAs are used as temperature transducers, optionally with SIL and Ex i approval, for the accurate and error-free transmission of measuring signals.



Temperature



	Description	Item no.	Type
	Ex i temperature transducer for VIP I/O marshalling base elements: converts signals from resistance thermometers installed in the Ex area and transmits a 0/4 ... 20 mA signal to a load (active or passive) in the safe area. Freely configurable.	1085764	IOA MCR-EX-RTD-I
	Ex i temperature transducer for VIP I/O marshalling base elements: converts signals from thermocouples installed in the Ex area and transmits a 0/4 ... 20 mA signal to a load (active or passive) in the safe area. Freely configurable.	1085766	IOA MCR-EX-TC-I
	Temperature transducer for VIP I/O marshalling base elements: converts signals from resistance thermometers and transmits a 0/4 ... 20 mA signal to a load (active or passive). Freely configurable.	1007728	IOA MCR-RTD-I
	Temperature transducer for VIP I/O marshalling base elements: converts signals from thermocouples and mV sources and transmits a 0/4 ... 20 mA signal to a load (active or passive). Freely configurable.	1007722	IOA MCR-TC-I

Passive modules

The passive function blocks perform a variety of basic functions, such as protecting signal and supply paths, limiting current and voltage to the field, and unfiltered signal forwarding.



Passive

	Description	Item no.	Type
	Feed-through terminal block for VIP I/O marshalling base elements for conveying field signals to or from the I/O system.	2906598	IOA FEED-THRU/EX
	Fuse module for VIP I/O marshalling base elements with replaceable 0.25 A fuse in the field device supply path. Integrated test points and a disconnect knife allow uninterrupted signal measurement.	1188706	IOA PR-DAI/DAO/F/DS/0.25A/EX
	Fuse module for VIP I/O marshalling base elements with replaceable 2 A fuse in the field device supply path. Integrated test points and a disconnect knife allow uninterrupted signal measurement.	1048208	IOA PR-DAI/DAO/F/DS/2A/EX
	Fuse module for VIP I/O marshalling base elements with replaceable 0.5 A fuses in the field device supply path and in the signal path. Integrated test points and a disconnect knife allow uninterrupted signal measurement.	2906599	IOA AI/AO/BFI/DS/0.5A/EX
	Fuse module for VIP I/O marshalling base elements with replaceable 1 A fuses in the field device supply path and in the signal path. Integrated test points and a disconnect knife allow uninterrupted signal measurement.	2906600	IOA DI/DO/BFI/DS/1.0A/EX

Process displays and field devices

3

The Field Analog process indicators enable you to monitor and locally display analog and temperature signals, and to control them via digital and analog inputs and outputs. The loop-powered temperature transducers acquire and convert the signals from resistance thermometers, thermocouples, resistance-type sensors, and voltage sensors directly in the field and convert them into standard and HART® signal.



Field Analog field devices

- Loop-powered temperature transducers
- Loop-powered temperature head-mounted transducers

Field Analog process displays

- Multifunctional process displays
- Output-loop-powered process displays
- 7-segment LED indicators



HART® communication

- For online configuration and diagnostics for HART®-compatible field devices
- Continuous documentation of process variables and states via PC or management system

Process displays and field devices

Process displays

The Field Analog series process displays enable you to monitor and display analog and temperature signals, and to control them via digital and analog inputs and outputs, even in the Ex area. The products are available for control-panel mounting or for decentral installation directly in the field. Benefit from easy configuration, good readability, and international approvals.



Your advantages

- ✓ Easy configuration of process indicators, either via front keypad or using FDT/DTM software
- ✓ Everything at a glance on the display: values, bar graphs, or measuring point designations, plus color change in the event of an error
- ✓ Easy installation with standardized housing dimensions and plug-in connection terminal blocks
- ✓ Digital transfer and display of process data with HART®-compatible display versions
- ✓ Suitable for global use due to international approvals
- ✓ Also for intrinsically safe circuits in the Ex area: versions with ATEX/IECEX, CSA, and FM approval

Your advantages in detail



Multifunctional process displays

Our multifunctional process displays acquire current, voltage, RTD, TC, and resistance-type sensor signals via the universal input. Current process values are easy to read on the five-digit backlit displays. The bar graph also provides you with a quick overview. Alarm states can be identified easily from a distance because the display changes to red.



Output-loop-powered process displays

The output loop-powered process displays display your 4 ... 20 mA and HART® signals. Up to four alternating measured values from a sensor are mapped via HART®. Benefit from the low voltage drop of less than one volt (<1.9 V HART®) when used in Ex applications, where only a limited voltage is usually available.



7-segment LED indicators

The compact process displays offer you cost-efficient monitoring of standardized current and voltage signals as well as frequency and pulse signals. In addition, the setpoint adjuster for standard signals helps you to easily integrate standardized signals or a freely programmable, time-controlled signal sequence of 0 ... 12 V or 0 ... 24 mA into your process.

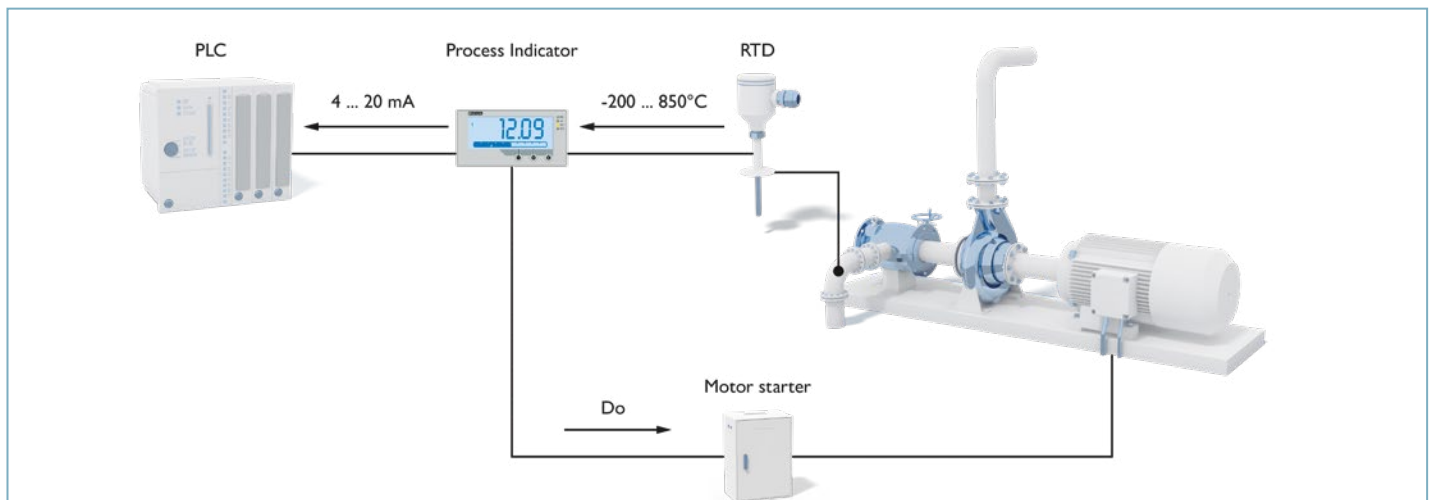

Recording limit values with multifunctional Field Analog process displays







The multifunctional FA MCR(-EX)-D-TUI-UI-2REL-UP process displays are particularly suitable as limit switches for monitoring limit values. The products continuously record your process values and switch the relay outputs as soon as a value exceeds or drops below the set limit value.

Example of pumped-medium temperature monitoring

In pump applications, it is useful to monitor the liquid being pumped. This helps in preventing drive overloads. If the solidifying point of the pumped medium is above the ambient temperature, the medium temperature monitoring system stops the pump from starting up until the

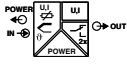
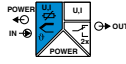
viscosity of the medium allows operation. In this process, the temperature signals are continuously monitored for upper and lower limit violations and controlled by the process display.

Product overview – Field Analog process displays

Multifunctional process displays	
	
	
Product type	Digital display
	
	
Description	Multifunctional process display in the control panel component housing, wide range power supply
	
Approvals	
Ex installation / Ex i switching circuit	
Usable input source	RTD: Pt, Ni, Cu sensors / 2-, 3-, 4-conductor / TC: J, K, T, N, B, S, R, U, L, C, D
Input signal	0 mA ... 20 mA +10 % / 4 mA ... 20 mA +10 % / 0 V ... 10 V / 2 V ... 10 V / 0 V ... 5 V / 0 V ... 1 V / 1 V ... 5 V / -1 V ... 1 V / -10 V ... 10 V / -30 V ... 30 V / -100 mV ... 100 mV / Resistance thermometers: -200°C ... 1100°C (range depending on sensor type, adjustable) / Thermocouples: -200°C ... 2495°C (range depending on sensor type, adjustable)
Output signal	0 mA ... 20 mA / 4 mA ... 20 mA / 0 V ... 10 V / 2 V ... 10 V / 0 V ... 5 V / 1 V ... 5 V
Switching output	Relay output (2 changeover contacts) / transistor output, active (open collector output)
Display	Number of digits displayed: 5 / 7-segment LC display, with backlight, dot matrix for text/bar graph
Supply voltage	24 V AC/DC ... 230 V AC/DC
Ambient temperature range	-20°C ... +60°C
Fault signaling: LED	Yes
Configuration	Keyboard / software
Mounting type	DIN rail mounting / front panel installation
Width	96 mm
Delivery state	Standard configuration
Type	FA MCR-D-TUI-UI-2REL-UP
	FA MCR-EX-D-TUI-UI-2REL-UP
Connection method	Push-in connection
Item number	2907064
	2907216

 The module can be snapped onto the DIN rail connector for 24 V voltage bridging

 Wide range input for worldwide supply networks











Product overview – Field Analog process displays

1

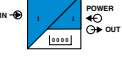

2

3

Process displays and field devices

Output-loop powered process displays				
				
Product type	Digital display			
				
Description	Output loop-powered process display in a control panel housing, HART-compatible	Output loop-powered Ex i process display in a control panel housing, HART-compatible	Output loop-powered process display in a field housing, HART-compatible	Output loop-powered Ex i process display in a field housing, HART-compatible
Approvals				
Ex installation / Ex i switching circuit		Gb; Div. 1		Gb; Div. 1
Input signal	4 mA ... 20 mA / up to 4x HART process variables			
Output signal	4 mA ... 20 mA / up to 4x HART process variables			
Display	Number of digits displayed: 5 / 7-segment LC display, with backlight, dot matrix for text/bar graph			
Supply voltage	Loop-powered, no external supply necessary			
Ambient temperature range	-40°C ... +60°C			
Fault signaling: LED	No			
Configuration	Keyboard / software			
Mounting type	Front panel installation / DIN rail		Wall mounting / pipe mounting	
Width	96 mm		131 mm	
Delivery state	Standard configuration			
Type	FA MCR-DS-I-I-OLP	FA MCR-EX-DS-I-I-OLP	FA MCR-FDS-I-I-OLP	FA MCR-EX-FDS-I-I-OLP
Connection method	Push-in connection			
Item number	2908781	2908800	2908782	2908801

LED displays

	Description	Item no.	Type
	MCR digital display, for measuring and displaying standard signals, 5-digit display	2864011	MCR-SL-D-U-I
	Digital setpoint adjuster with manual and automatic ramp for defining current and voltage signals, 4-digit display	2710314	MCR-SL-D-SPA-UI
	MCR digital display, for measuring and displaying frequencies, pulses, and times, 6-digit display	2864024	MCR-SL-D-FIT

Process displays and field devices

Loop-powered temperature transducers

Our loop-powered Field Analog temperature transducers acquire and convert signals from temperature sensors such as resistance thermometers, thermocouples, and resistance and voltage sensors into a standard signal directly in the field. Via HART® communication, you can transfer process data digitally and configure the transmitter remotely. The products are available for the DIN rail or as head-mounted transducers.

Push-in Technology 
Designed by Phoenix Contact



Your advantages

- ✓ Record temperatures directly in the field without a separate power supply with loop-powered supply from the measuring circuit
- ✓ Use in harsh environments in the process, oil, and gas industry with robust field housings from our range of accessories
- ✓ Equipped with integrated HART® communication, which enables process data to be transferred and displayed digitally, and also parameterized remotely
- ✓ Suitable for global use due to international approvals
- ✓ Also for intrinsically safe circuits in the Ex area: versions with ATEX/IECEX, CSA, and FM approval

Your advantages in detail



Supply from the measuring circuit

All Field Analog temperature transducers are 2-wire transmitters. You do not need a separate power supply, as the products are supplied with power directly via the 4 mA ... 20 mA measuring line. This reduces wiring effort.



Convenient configuration and monitoring

Conveniently configure the temperature transducers and head-mounted transmitters of the Field Analog product family via HART® communication. In addition, you have the option of receiving extended process data and extensive diagnostic functions from the device via HART®.

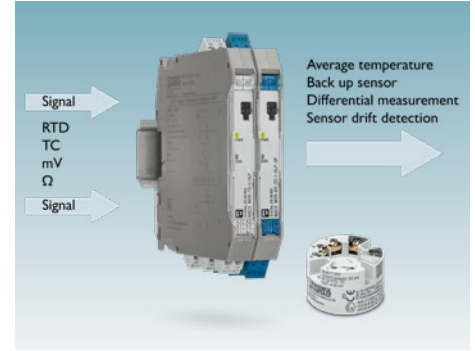

Dual sensor input

Depending on the device type, some field analog temperature transmitters have a dual sensor input. This allows mathematical functions to be mapped, such as a difference measurement. It is also possible to monitor a process with two different temperature sensors and to switch over from a defined temperature range.



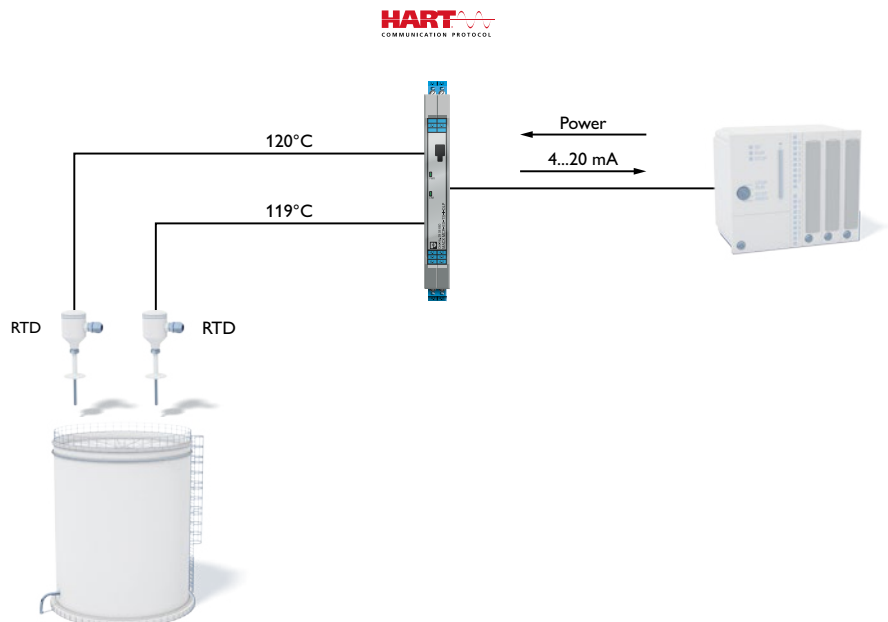

Easy detection of temperature deviations

With the FA MCR(-EX)-HT-TS-I-OLP and MACX MCR(-EX)-TS-I-OLP(-SP) (-C) temperature transmitters, it is easy to detect temperature deviations in a process. To do this, you can use the dual sensor input of the devices and connect two sensors: For example, you can use two 2-conductor PT100 sensors or one 4-conductor PT100 and one TC sensor. Configuring the temperature transmitter for recording the temperature difference is convenient and simple via the fdtContainer and corresponding DTM. If the temperature at the measuring point deviates, a HART® signal is generated which signals the deviation to the controller.

* Please note that two temperature transmitters must be used for SIL 3 applications.

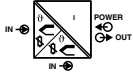
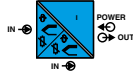

Product overview – Field Analog field devices

Head-mounted transducers / 2-conductor field devices		
		
Product type	Temperature transducer	
		
Description	Output loop-powered head-mounted temperature transducer for RTDs, TCs, resistance-type sensors, and voltage sensors, two measuring inputs	Output loop-powered Ex i head-mounted temperature transducer for RTDs, TCs, resistance-type sensors, and voltage sensors, two measuring inputs
Approvals		
Ex installation / Ex i switching circuit	Gc; Div. 2	Ga; Div. 1 / Gb; Div. 1
Functional safety	SIL 2 / SC 3	
Usable input source	RTD: Pt, Ni, Cu sensors: 2-, 3-, 4-conductor / TC: A, B, C, D, E, J, K, L, N, R, S, T, U	
Input signal	-250°C ... 2500°C (range depending on the sensor type) / linear resistance: 10 Ω ... 2000 Ω (minimum measuring span: 10 Ω) / -20 mV ... 100 mV (minimum measuring span: 5 mV)	
Output signal	4 mA ... 20 mA / 20 mA ... 4 mA	
Supply voltage	Loop-powered, no external supply necessary	
Ambient temperature range	-40°C ... +85°C	
Fault signaling: LED	No	
Configuration	Software / HART	
Mounting type	Installation / DIN rail mounting	
Delivery state	Standard configuration	
Type	FA MCR-HT-TS-I-OLP	FA MCR-EX-HT-TS-I-OLP
Connection method	Screw connection	
Item number	1105515	1105681







Product overview – Field Analog field devices

1



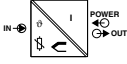
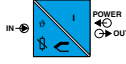





2

3

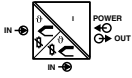
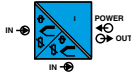
Process displays and field devices

Head-mounted transducers / 2-conductor field devices		
	 	
Product type	Temperature transducer	
	 	
Description	Output loop-powered head-mounted temperature transducer for RTDs, TCs, resistance-type sensors, and voltage sensors, one measuring input	
	Output loop-powered Ex i head-mounted temperature transducer for RTDs, TCs, resistance-type sensors, and voltage sensors, one measuring input	
Approvals		
Ex installation / Ex i switching circuit	Gc; Div. 2	
Usable input source	RTD: Pt, Ni, Cu sensors: 2-, 3-, 4-conductor / TC: A, B, C, D, E, J, K, L, N, R, S, T, U	
Input signal	-250°C ... 2500°C (range depending on the sensor type) / linear resistance: 10 Ω ... 2000 Ω (minimum measuring span: 10 Ω) / -20 mV ... 100 mV (minimum measuring span: 5 mV)	
Output signal	4 mA ... 20 mA / 20 mA ... 4 mA	
Supply voltage	Loop-powered, no external supply necessary	
Ambient temperature range	-40°C ... +85°C	
Fault signaling: LED	No	
Configuration	Software / HART	
Mounting type	Installation / DIN rail mounting	
Delivery state	Standard configuration	
Type	FA MCR-HT-1TS-I-OLP	FA MCR-EX-HT-1TS-I-OLP
Connection method	Screw connection	
Item number	1145210	1145217

Product overview – Field Analog field devices

2-conductor field devices						
						
Product type	Temperature transducer					
						
Description	Output loop-powered temperature transducer for RTDs, TCs, two measuring inputs			Output loop-powered Ex i temperature transducer for RTDs, TCs, two measuring inputs		
Approvals						
Approvals						
Ex installation / Ex i switching circuit	Gc; Div. 2			Gb; Div. 1		
Functional safety	SIL 2 / SC 3					
Usable input source	RTD: Pt, Ni, Cu sensors / 2, 3, 4-conductor / TC: A, B, C, D, E, J, K, L, N, R, S, T, U					
Input signal	-250°C ... 2500°C (range depending on the sensor type) / linear resistance: 10 Ω ... 2000 Ω (minimum measuring span: 10 Ω) / -20 mV ... 100 mV (minimum measuring span: 5 mV)					
Output signal	4 mA ... 20 mA / 20 mA ... 4 mA					
Supply voltage	Loop-powered, no external supply necessary					
Ambient temperature range	-40°C ... +85°C					
Fault signaling: LED	Yes					
Configuration	Software / HART					
Mounting type	DIN rail mounting					
Width	12.5 mm					
Delivery state	Standard configuration		Order configuration	Standard configuration		Order configuration
Type	MACX MCR-TS-I-OLP(-SP)		MACX MCR-TS-I-OLP-C	MACX MCR-EX-TS-I-OLP(-SP)		MACX MCR-EX-TS-I-OLP-C
Connection method	Push-in connection	Screw connection		Push-in connection	Screw connection	
Item number	2908664	2908662	1012249 new	2908661	2908660	1012248 new









Product overview – Field Analog field devices

1

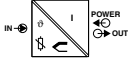
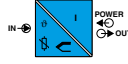
2

3

Process displays and field devices

2-conductor field devices			
			
Product type	Temperature transducer		
			
Description	Output loop-powered temperature transducer for RTDs, TCs, one measuring input		Output loop-powered Ex i temperature transducer for RTDs, TCs, one measuring input
			
Approvals			
Ex installation / Ex i switching circuit	Gc; Div. 2		Gb; Div. 1
Usable input source	RTD: Pt, Ni, Cu sensors: 2-, 3-, 4-conductor / TC: A, B, C, D, E, J, K, L, N, R, S, T, U		
Input signal	-250°C ... 2500°C (range depending on the sensor type) / linear resistance: 10 Ω ... 2000 Ω (minimum measuring span: 10 Ω) / -20 mV ... 100 mV (minimum measuring span: 5 mV)		
Output signal	4 mA ... 20 mA / 20 mA ... 4 mA		
Supply voltage	Loop-powered, no external supply necessary		
Ambient temperature range	-40°C ... +85°C		
Fault signaling: LED	Yes		
Configuration	Software / HART		
Mounting type	DIN rail mounting		
Width	12.5 mm		
Delivery state	Standard configuration		
Type	MACX MCR-1TS-I-OLP(-SP)		MACX MCR-EX-1TS-I-OLP(-SP)
Connection method	Push-in connection	Screw connection	Push-in connection Screw connection
Item number	1145196	1145192	1145207 1145365

Process displays and field devices

HART® communication





The HART® product portfolio provides you with expertise from HART®-transparent interface modules as well as HART®-compatible field devices. A display for control-panel mounting or field installation is available to display the HART® variables. In addition, the HART® multiplexer enables bidirectional communication with up to 32 HART®-compatible field devices. Interconnecting several multiplexer devices enables up to 4000 channels to be visualized on one PC.



Your advantages

- ✓ Easy online configuration and diagnostics for HART®-compatible field devices
- ✓ Continuous documentation of process variables and states via PC or management system
- ✓ No influence on measured value processing due to parallel access to the HART® field devices
- ✓ Processing of more than 4000 channels on one PC, by connecting up to 128 HART® multiplexers with 32 channels each

Product overview

HART communication			
	Description	Item no.	Type
	HART multiplexer for the online configuration and diagnostics of HART-compatible field devices as well as the continuous documentation of process variables and states using a PC or management system, for mounting on NS 35/7.5 or NS 32	2865599	MACX MCR-S-MUX
	The HART termination board is used to apply the signals from the HART-compatible signal converters or field devices and transmit them to the MACX MCR-S-MUX HART multiplexer.	2308124	MACX MCR-S-MUX-TB
	The HART termination board is used to apply the signals from the HART-compatible signal converters or field devices and transmit them to the MACX MCR-S-MUX HART multiplexer. The output terminal strip ensures that the analog signals are forwarded.	1292339 new	MACX MCR-S-MUX-TB-1
	USB HART modem cable for communication between a PC and HART devices, cable length: 1 m.	1003824	GW HART USB MODEM

Our services for signal conditioning and explosion protection

Your individual product with factory calibration certificate

Simply order the suitable product online with the individual configuration for your application. You will then receive modules that are preconfigured to your specifications – even in a minimum quantity of one unit.

Optionally, simply order the appropriate factory calibration certificate for your preconfigured products. The test data is already determined during the production process and supplied directly with the product. This saves you having to deal with an external test laboratory. The certificates are available with or without test data.

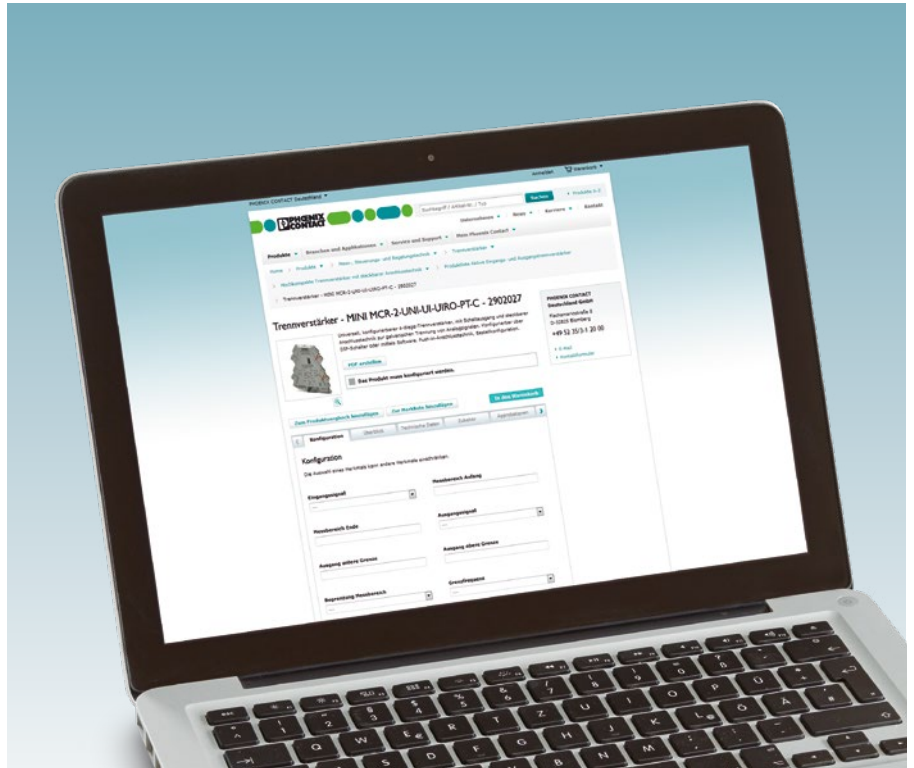

Signal Conditioner App

Configuration, monitoring, identification, all in the palm of your hand: The Signal Conditioner App enables you to identify and configure your products as well as monitor process values more easily than ever before. You also have access to module-specific documents, such as packing slips and data sheets. A DIP switch setting help is available for products with DIP switches.

Easy connectivity via NFC (MINI Analog Pro), Bluetooth, or QR code. The app is available free of charge for both Android and Apple iOS smartphones.

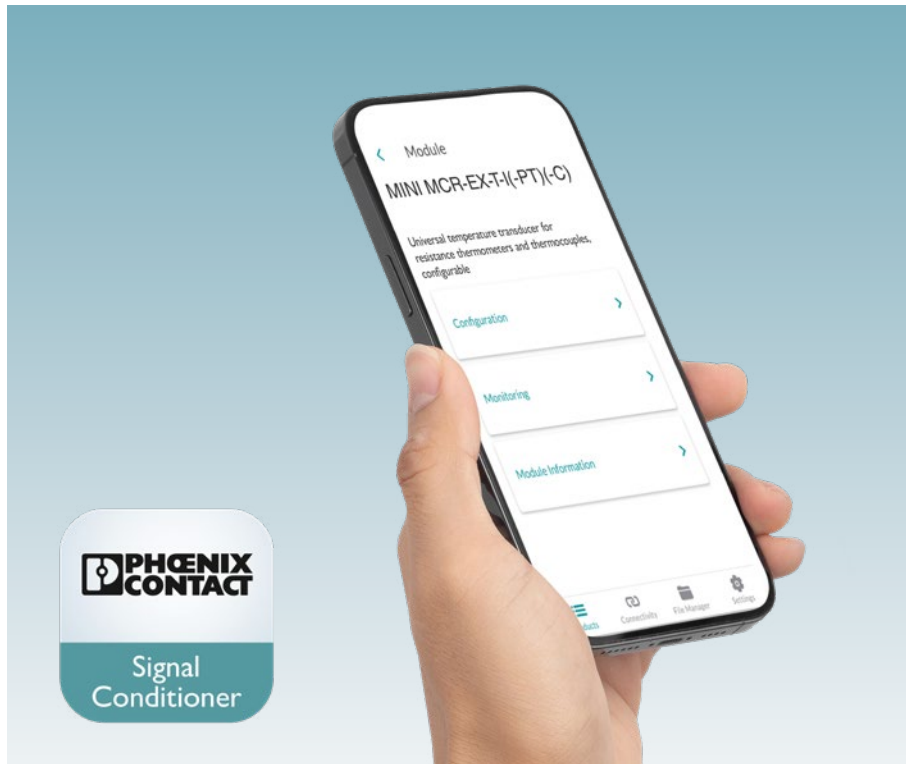

clipx ENGINEER software

The configuration software for Phoenix Contact devices includes online monitoring of your current device process values, adjustment of device parameters, and logging of parameter changes. The software is available as a Windows installation version with online update.

Your advantages

- Smart interfaces to Phoenix Contact applications for control cabinet building and to your CAE programs
- Simplified planning of your projects with the support of intelligent engineering assistants
- Seamless processes from planning to your production through the provision of complete digital data
- Maximum availability for your engineering process with online and offline use



Services for safety and security in the industry

As a product-independent service provider, we will help you minimize safety and liability risks.

Process reliability

- Systematic hazard and risk analysis in accordance with DIN EN 61511, including HAZOP study
- Consulting and support for the preparation of SIL assessments in accordance with IEC 61508 and IEC 61511
- Validation of the safety functions and proof test
- Advice on the use of explosion protection components and on operating in explosive atmospheres in accordance with 2014/34/EU and 1999/92/EC

Discover other areas of expertise, such as Industrial Security, CE Marking, and Occupational Safety on our website or in our "Services for safety and security in the industry" brochure.



Further products for signal conditioning and explosion protection

System cables for quick plug-in connections

System cables with D-SUB or IDC/FLK connectors provide a quick and error-free connection between the automation device and termination board. Choose from a wide range of preassembled system cables in various numbers of positions. They can be connected using pin strips or female strips – optionally via single-core wires as free cable end with ferrules.

You will find more information about this on our website and in the “System cabling for controllers” product brochure.

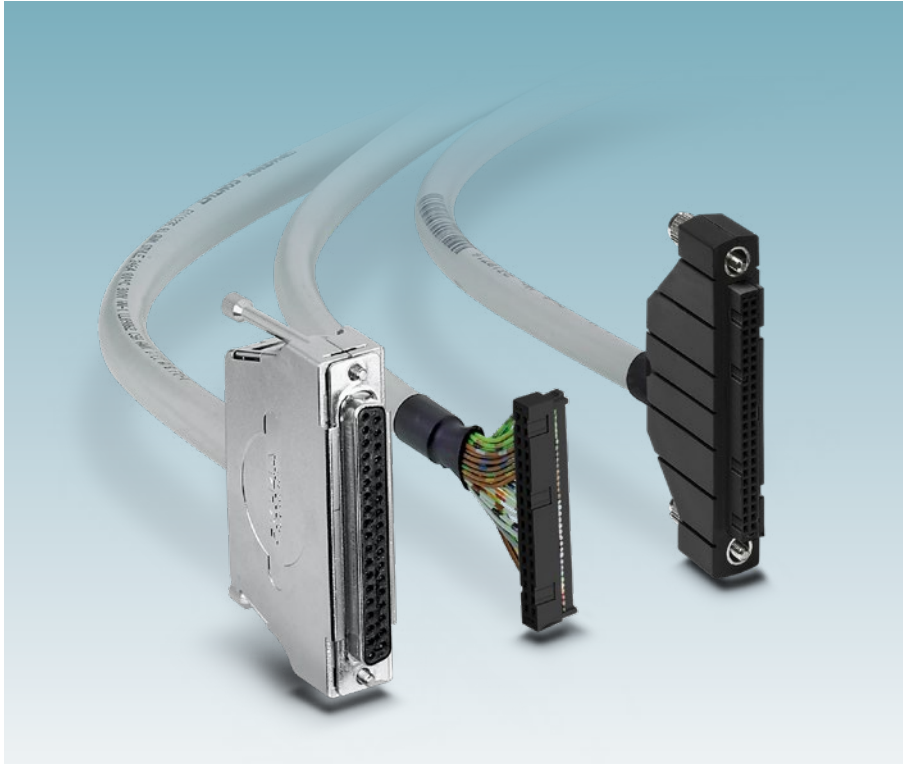

Surge protection for measurement and control technology

The interfaces in measurement and control technology are particularly sensitive. Even low surge voltages have the potential to disrupt the smooth operation of building control technology, production, and process technology. Surge protection systems specially tailored to the requirements enable the interference-free transmission of signals.

You will find more information about this on our website and in the “Surge protection” product brochure.

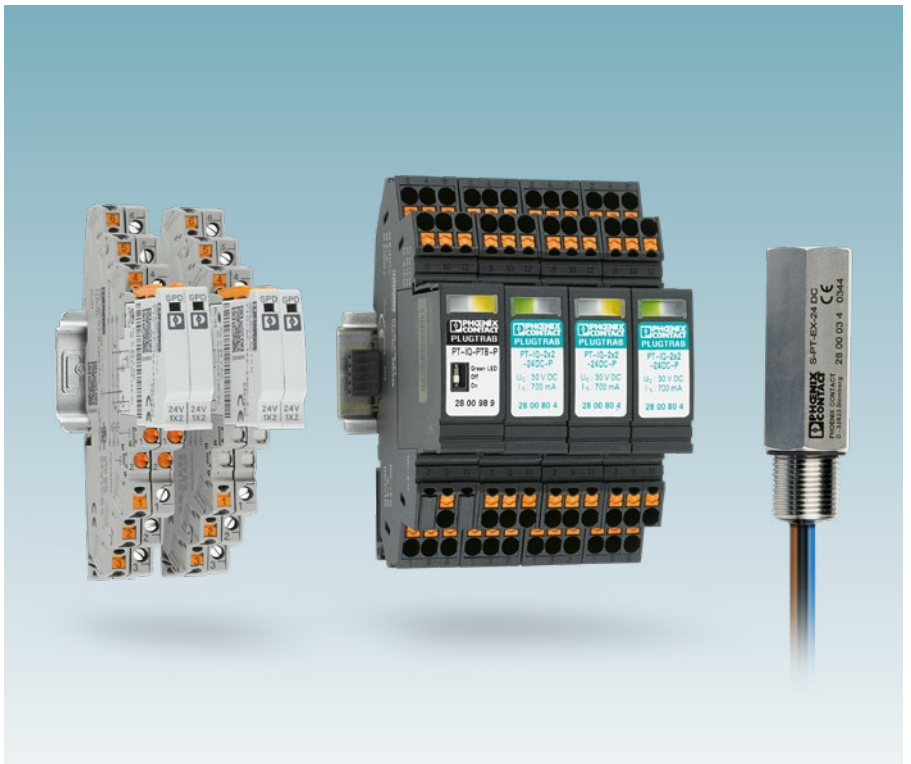

Marshalling terminals, potential distributors, and marshalling patchboards

The marshalling panels allow you to distribute your signals easily and clearly. The product family is comprised of marshalling terminals and potential distributors for simple DIN rail mounting.

The marshalling patchboards help you to marshal signals easily. The marshalling patchboards are suitable for direct mounting, DIN rail mounting, and mounting in a 19-inch rack. The high-level modularity of the patchboards means you can realize exactly the right number of positions.

Are you also interested in this subject? You will find more information about this on our website and in the “Marshalling panel” product brochure.

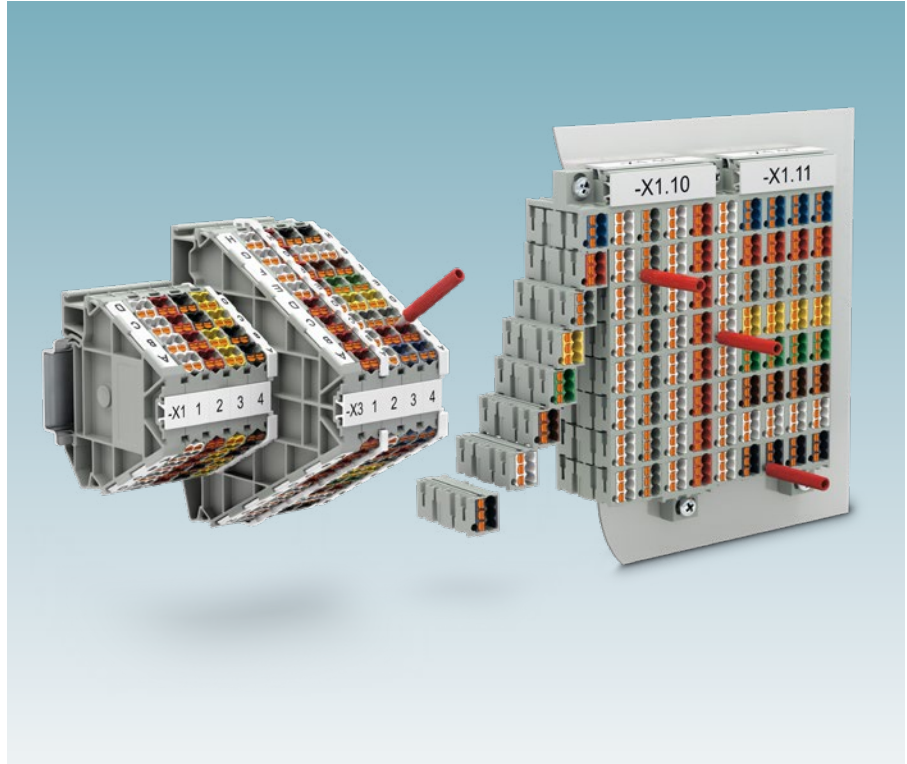

Safety relay modules and sensors

Using our safety relay modules, you can reliably implement safety functions in machines and systems. The products monitor signals from emergency stop buttons, light grids, and safety door switches, and initiate a safe state where necessary. The PSR product family comprises safety relays with fixed or configurable safety functions, over-speed and zero-speed safety relays, and safe coupling relays.

You will find more information about this on our website and in the “Functional safety” product brochure.

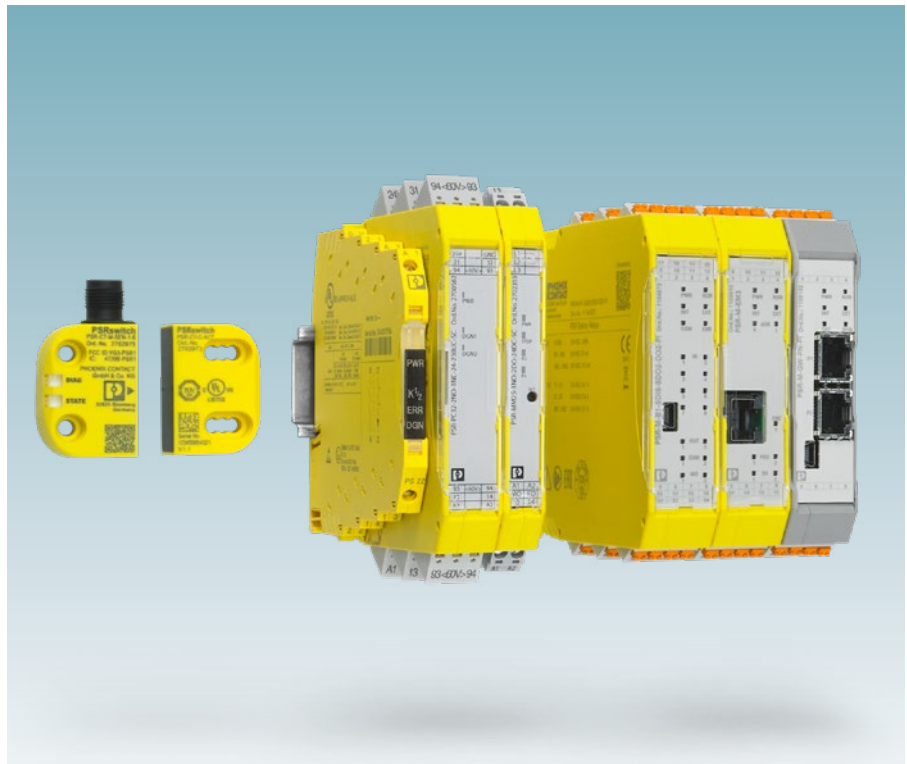

COMPLETE line – the comprehensive solution for the control cabinet

COMPLETE line is a system comprising technologically leading and coordinated hardware and software products, consulting services, and system solutions that help you optimize your processes in control cabinet building. Engineering, purchasing, installation, and operation become significantly easier for you.



i Web code: #2089

Your advantages in detail:

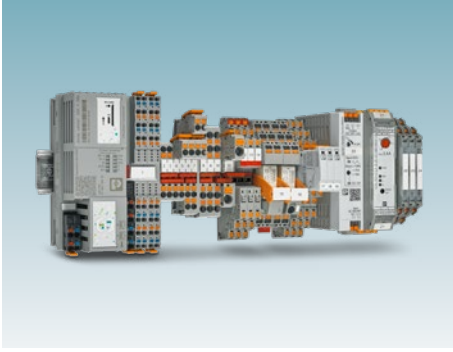

Comprehensive product portfolio

With COMPLETE line, we offer a complete product portfolio of technologically leading products. This includes:

- Controllers and I/O modules
- Power supplies and device circuit breakers
- Terminal blocks and distribution blocks
- Relay modules and motor starters
- Signal conditioners
- Safety technology
- Surge protection
- Heavy-duty connectors

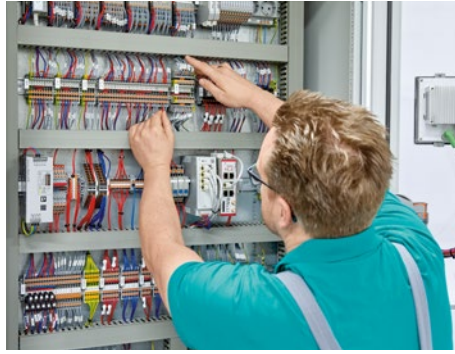

Intuitive handling

Thanks to the simple, intuitive handling of the coordinated hardware products you will save time regarding assembly, startup, and maintenance. Push-in connection technology enables you to wire applications quickly – completely tool-free. The broad, technologically leading product portfolio will always provide you with the right product for standard or special applications.

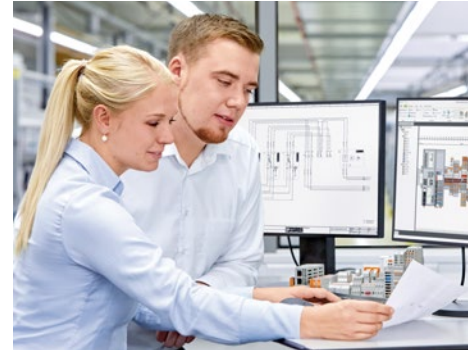

Save time throughout the entire engineering process

PROJECT complete planning and marking software supports the entire process of control cabinet building. The program features an intuitive user interface that enables the individual planning, automatic checking, and direct ordering of terminal strips.



Reduced logistics costs

Reduced variety of parts with standardized marking, bridging, and testing accessories. The COMPLETE line system coordinates products, design, and accessories so that you benefit from maximum reusability and thus reduce your logistics costs.



Optimized processes in control cabinet building

COMPLETE line supports you, from engineering through to manufacturing, in designing your control cabinet production as efficient as possible. Thus, your customized concept for optimizing your processes in control cabinet building is created. Our terminal strip production helps you to flexibly manage order peaks or to supply your control cabinet production with fully assembled DIN rails just in time.



The new standard for the control cabinet

Discover the extensive COMPLETE line product portfolio and find out more about COMPLETE line and your comprehensive solutions for the control cabinet.

Visit our website:

phoenixcontact.com/completeline

Worldwide service and support: We are there for you

At Phoenix Contact, the focus is always on you, the customer. With over 50 subsidiaries and more than 30 agencies around the world, we are always close by.

As a result, you receive expert, first-hand advice and benefit from fast and timely delivery of a complete package consisting of high-quality, optimally coordinated components. Our expertise and the high levels of vertical integration also allow customized solutions tailored to you. We will also support you after the purchase with comprehensive after-sales services.

 Web code: #2247



Your advantages in detail:



Fast terminal strip production

Our terminal strip production service provides help in managing order peaks flexibly and allows terminal strips to be delivered just in time for series production. The fully assembled and marked terminal strips, already equipped with accessories, just need to be installed and connected.



Individual set solutions

To reduce the effort of materials and stock management, you can order pre-picked material sets under a single item number.



Customer-specific solutions

Can't find what you're looking for in our range? No problem: From minor adaptations to completely new product developments, we focus on your specific requirements.



Global approvals and certificates

Our numerous certificates are proof that you can put your full trust in our products, because quality is essential. We strive to satisfy this claim in every respect. For this reason, our systems, processes, and products are tested and certified several times over.



Comprehensive after-sales services

We are there for you – not just before your purchase, but also after with our comprehensive after-sales services. This includes our repair service, exchange service, and replacement parts service.



Comprehensive training program

From the basics to specialist expertise: we provide you with the skills you need in line with your specific requirements.

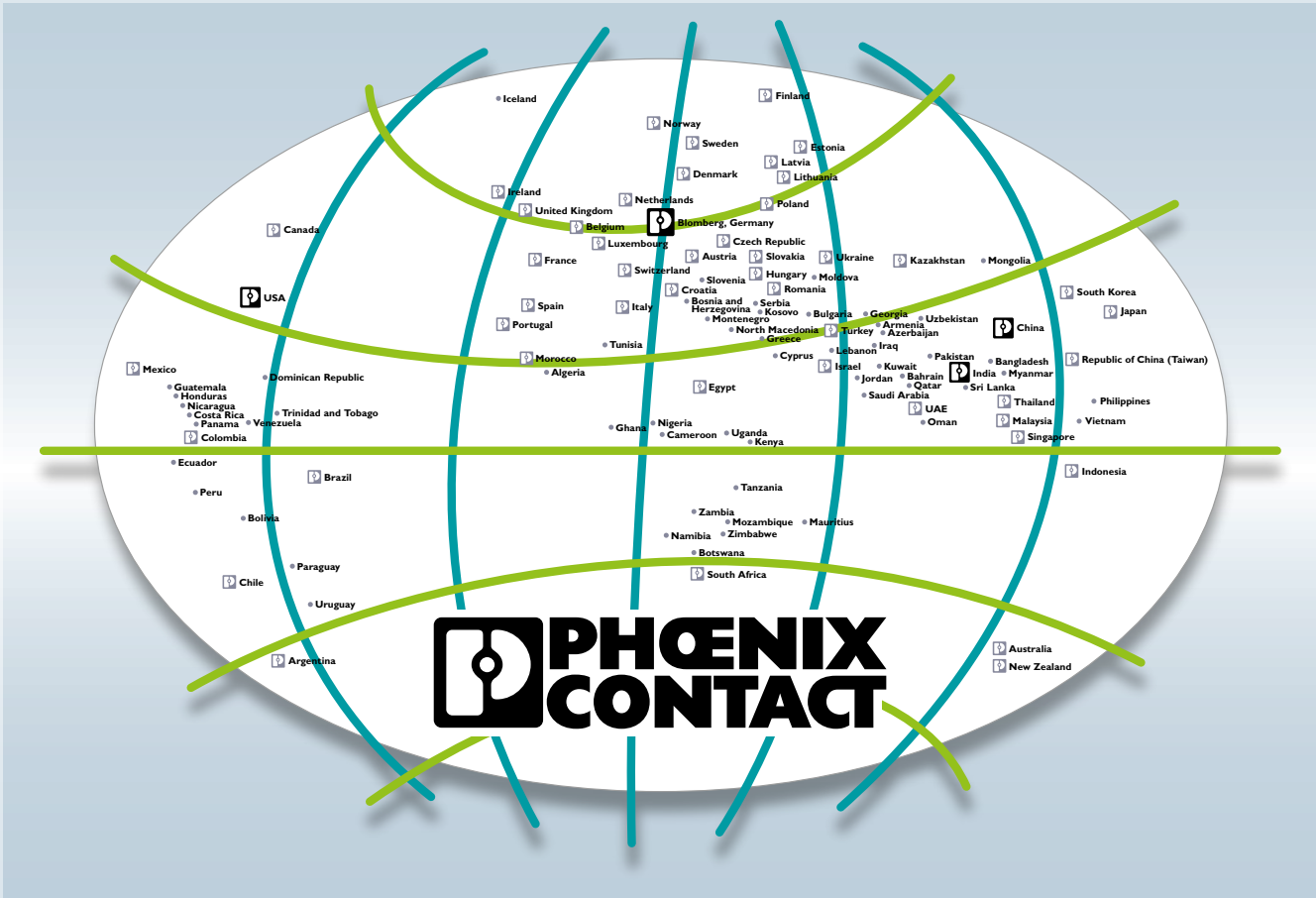

Open communication with customers and partners worldwide

Phoenix Contact is a global market leader based in Germany. We are known for producing future-oriented products and solutions for the electrification, networking, and automation of all sectors of the economy and infrastructure. With a global network reaching across more than 100 countries with over 22,000 employees, we maintain close relationships with our customers, something we believe is essential for our common success.

Our wide range of innovative products makes it easy for our customers to implement the latest technology in a variety of applications and industries. This especially applies to the target markets of energy, infrastructure, industry, and mobility.

You can find your local partner at

phoenixcontact.com